

7800/8200 Series

Mortise Locks



Table of Contents

8200/R8200/7800 Series Mortise Locks

SARGENT
ASSA ABLOY

Table of Contents

Certifications	3
Windstorm Certifications	3
Features	4-6
Simpli™ Roseless Trim & R8200 Mortise Locks	7
Studio Collection Levers & Trim	8-10
Coastal Series™ & Standard Levers & Trim	11-12
8200 Escutcheon Designs	13
Freewheeling (FE) Trim Design, ADA & Handicap Warning	14
7800 Knob and Rose Designs	15
7800 Series Escutcheon Designs	16
Behavioral Health Series™ Trim	17
7800 PT Push/Pull Trims & 7800/8200 Anti-Vandal Option	18
Functions & Descriptions	19-28
Electrical Functions & Monitoring Options	29-30
Electrical Requirements & Accessories	31
Indicators	32-37
Thumbturn Designs	38
Emergency Releases, Indicators & Accessories	39
Cylinders	40
Cylinders & Rosettes	41
Rosette Requirements & Cams	42
Strikes & Fronts	43
ADA and Handicap Warning	44
Mechanical Options	45-46
Cylinder Options	47-48
How to Order, Finishes, Packaging & Security Screw Chart	49
How to Order Gramercy Series Levers	50
Multi-Functional Lockbody	51
Architectural Specifications	52

MicroShield®

ASSA ABLOY Group companies offer MicroShield®, an anti-microbial coating for door hardware. MicroShield uses proven silver ion-based technology from Agion®, a leading provider of antimicrobial solutions, to stem the spread of bacteria and other microbes.

MicroShield® is a registered trademark of ASSA ABLOY Access and Egress Hardware Group, Inc.



The Agion antimicrobial is not intended as a substitute for good hygiene. Coated products must still be cleaned to ensure the surfaces will be free of destructive microbes. ASSA ABLOY makes no representations or warranties, express or implied, as to the efficacy of the Agion antimicrobial. A copy of the Agion warranty is available upon request. Agion is a registered trademark of Agion Technologies, Inc., Wakefield, MA, USA

Copyright © 2004-2021, SARGENT Manufacturing Company. All rights reserved. Reproduction in whole or in part without the express written permission of SARGENT Manufacturing Company is prohibited. Patent pending and/or patent www.assaabloy.com/patents.

Certification Compliance

ANSI/BHMA		Certified to ANSI/BHMA A156.13 Series 1000 Operational Grade 1 and Security Grade 1 with all standard trims. Note: LFIC (Removable) Cylinders and SFIC Cylinders do not meet Security Grade 1 requirements.
ADA		Meets A117.1 Accessibility Code. Meets BOMA International 4.13.8 Complies with American Disability Act; Consult local authorities
UL-cUL		UL and cUL Listed to US and Canadian safety standards for A label 4 x 10 single and 8 x 10 double (3 hour fire door) and lesser class doors, stamped letter F and UL symbol on armored front indicate listing
Positive Pressure		Meets ANSI/UL 10C, Positive Pressure Fire Test of Door Assemblies
California		California State Reference Code (Formerly Title 19, California State Fire Marshal Standard) All levers with returns comply; levers return to within 1/2" (13mm) of door face
Tornado and Hurricane Codes		See below

Any retrofit or other field modification to a fire rated opening can potentially impact the fire rating of the opening, and Sargent Manufacturing Company makes no representations or warranties concerning what such impact may be in any specific situation. When retrofitting any portion of an existing fire rated opening, or specifying and installing a new fire-rated opening, please consult with a code specialist or local code official (Authority Having Jurisdiction) to ensure compliance with all applicable codes and ratings.

Windstorm Certifications: Florida Building Codes & UL Listings

SARGENT Manufacturing's products meet building codes that require hurricane, windstorm and FEMA certifications, including some of the most stringent building codes as specified in the Florida Building Code, Miami Dade Code and the International Building Code. Listed below are certifications and standards met by the 7800/8200 lock.

Florida Building Code: FL2998

UL Certification Directory: ZHEM.R21744 – Latching Hardware

ANSI/SDI A250.13	"Testing and Rating of Severe Windstorm Resistant Components for Swinging Door Assemblies"
ASTM E330	"Standard Test Method for Structural Performance of Exterior Windows, Doors, Skylights and Curtain Walls by Uniform Static Air Pressure Difference"
ASTM E1886	"Standard Test Method for Performance of Exterior Windows, Curtain Walls, Doors, and Impact Protective Systems Impacted by Missile(s) and Exposed to Cyclic Pressure Differentials"
ASTM E1996 (2009)	"Standard Specification for Performance of Exterior Windows, Curtain Walls, Doors and Impact Protective Systems Impacted by Windborne Debris in Hurricanes"
(TAS) 201	"Impact Test Procedures"*
(TAS) 202	"Criteria for Testing Impact and Non-Impact Resistant Building Envelope Components Using Uniform Static Air Pressure"
(TAS) 203	"Criteria for Testing Products Subject to Cyclic Wind Pressure Loading"**

UL Certification Directory: ZHLL.R21744 – Products for Use in Windstorm-rated Assemblies

Certifications to meet assembly requirements are done in conjunction with doors from ASSA ABLOY Group companies CECO DOOR and CURRIES.

ASTM E330	"Standard Test Method for Structural Performance of Exterior Windows, Doors, Skylights and Curtain Walls by Uniform Static Air Pressure Difference"
ANSI/ASTM E1886	"Standard Test Method for Performance of Exterior Windows, Curtain Walls, Doors, and Impact Protective Systems Impacted by Missile(s) and Exposed to Cyclic Pressure Differentials"
ASTM E1996	"Standard Specification for Performance of Exterior Windows, Curtain Walls, Doors and Impact Protective Systems Impacted by Windborne Debris in Hurricanes"

* Any undated reference to a code or standard appearing in this catalog shall be interpreted as referring to the latest edition of that code or standard.

** Published in the 7th Edition (2020), "Florida Building Code" (FBC), State Product Approval Number FL2998

Features

8200/R8200/7800 Series Mortise Locks

SARGENT
ASSA ABLOY

The patented SARGENT Mortise Locks are designed and constructed with high quality components to provide maximum security, performance and durability. These locks represent over a century of innovation and experience in manufacturing hardware and are the industry's benchmark for mortise locks: strong, durable, flexible, innovative and secure.

Specifications

- For Doors 1-3/4" (44mm) thick standard
- Backset 2-3/4" (70mm) only
- Outside Front Plate Brass, bronze or stainless steel. 8" (203mm) x 1-1/4" (31mm), ANSI/BHMA Standard A156.115
- Front adjustable at any angle from flat to beveled 1/8" (3mm) in 2" (51mm)
- Hubs for Knobs/Levers
 - 7800: sintered iron copper infiltrated
 - 8200: cold forged steel
 - R8200: investment cast steel
- Auxiliary Deadlatch is stainless steel and non-handed
- Specify hand on order; easily field reversible (if no hand is specified RH will be provided)
- Strike: Brass, bronze or stainless steel; ANSI Standard; curved lip, non-handed (strike box optional)
- Keys: Two, nickel silver (control key or emergency key must be ordered when required)
- Cylinder: Brass, size #41 (1-1/8") standard (except for Freewheeling, size #46 (1-3/4"))
- Can be masterkeyed or grand masterkeyed. Construction keying available. LA standard keyway
- Stile: 4-1/2" (114mm) minimum stile for 7800/8200/R8200, 4-3/4" (121mm) minimum stile for electrical function locks
- Door Prep: ANSI/BHMA A156.115 or A156.115W modified per template (see template)
- Warranty: 10 year limited warranty, 2 year limited warranty on electrified locks. Warranty limited to replacement of lockbody and/or components

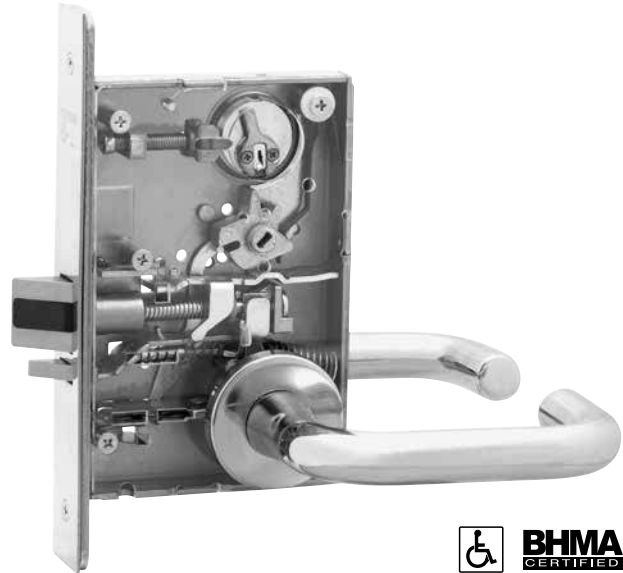

Hurricane

Maximum Strength & Durability

- Certified to and exceeds ANSI/BHMA A156.13, Series 1000, Operational Grade 1 and Security Grade 1 with all standard trims
- Exceeds cycle testing requirements by 14 times the ANSI/BHMA A156.13 Grade 1 standard
- Case: 12 gauge heavy duty wrought steel, zinc dichromate plated. Thickness 7/64" (3mm) (.109")
- 1/8" (.125") cold-rolled steel inside front holds lock securely in door
- Heavy duty wrought steel hubs and high carbon steel spring cartridge provide superior strength and cycle life for 8200 locks
- Latchbolt is stainless steel with 3/4" (19mm) projection one-piece, anti-friction reversible latch
- Deadbolt is one-piece hardened stainless steel with 1" (25mm) projection
- Optional 8200 stainless steel hubs for Institutional setting (specify 3- option)
- Patent pending and/or patent www.assaabloydss.com/patents

Features

8200/R8200/7800 Series Mortise Locks

Maximum Flexibility

- Fast and easy installation. Lock is easily re-handed without removing parts or opening the lock case
- Aesthetic design. Many escutcheon and lever styles available to match a wide range of styles
- Many standard architectural grade finishes, including Polished Nickel (US14) & Satin Nickel (US15) finishes
- 54 functions including 4 electrical functions. The most in the industry for a broad range of applications
- Versatile. Offered for door thicknesses ranging from 1-3/8" (35mm) to 6" (152mm)
- Available with vandalism deterrent trim and/or secure fastener options Torx® and spanner screws for high abuse conditions
- Available with push/pull trim, perfect for hospital applications
- Status indicator options provide peace of mind on the locked/unlocked status of a door

Innovation

- First in the industry to offer a multi-functional lockbody that embodies 8 functions in 1 lockbody
- Easy operation. Only 30° of lever rotation required to retract latchbolt
- Lever springs contained inside of the lock case for easier installation
- SARGENT's revolutionary MicroShield® available. This antimicrobial silver-based finish coating permanently suppresses the growth of bacteria, algae, fungus, mold and mildew. EPA and NSF approved and FDA listed
- Broad offering of electro-mechanical configurations offer higher security for the most demanding access/egress control applications featuring ElectroLynx® quick connectors

Security

- Multiple security trim options available: free-wheeling, security escutcheon and anti-vandal pull trim (patent pending)
- Security key systems available (Degree, Signature, Keso, Keso F1, & XC)

Features

8200/R8200/7800 Series Mortise Locks

SARGENT
ASSA ABLOY

8200 & 7800 Lockbody Dimensions

(R8200 Lockbody not shown)

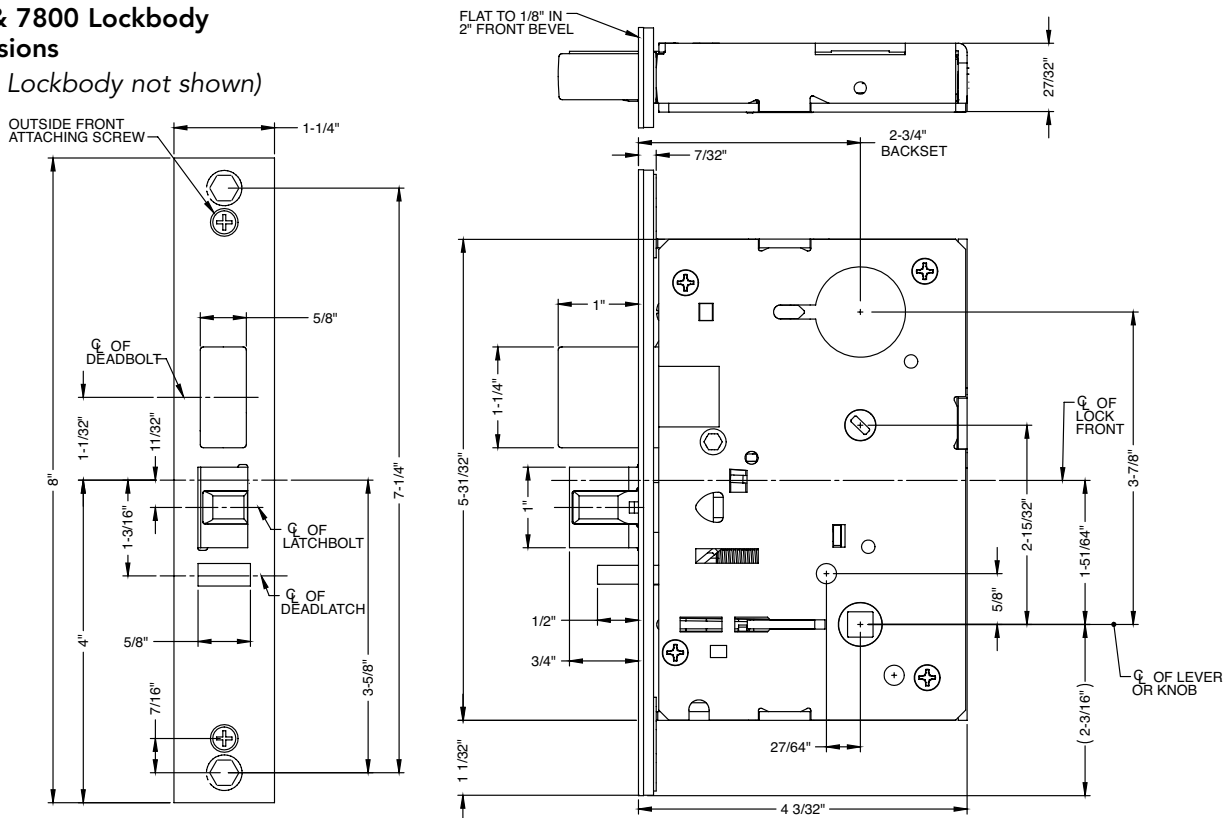

Note: R8200 and 8200 lockbodies are dimensionally the same except for the through-bolt locations

Explanation of the 8200/7800 Lockbody types:

Lockbody Type ¹	Trim Available x Lockbody type	Standard 8200 Door Prep	Through Bolted Trim	Multi-function lockbody available	How to order lockbody only
8200	Lever x Rose/Escutcheon	Yes	Yes	Yes	82 x Function x Finish ³
7800	Knob x Rose/Escutcheon	Yes	Yes	Yes	78 x Function x Finish ³
R8200	Simpli™ roseless trim	No	Yes ²	Yes	R82 x Function x Finish ³
8200 for ALP	ALP Push/Pull Trim	Yes	Yes	Yes	Six Digit Part # determined by function*
7800 PT	PT Push/Pull Trim	Yes	Yes	Yes	Six Digit Part # determined by function*

¹ Lockbodies can only be used with the specified trim

² Through Bolt locations are different from standard trim, special door prep required

³ **Note:** Cylinder and trim not included. Outside front, strike and screw pack are included

* See Price book; **Note:** Outside Fronts, Strikes, Cylinders and Trim are NOT included

Simpli™ Roseless Trim & R8200 Series Mortise Locks

SARGENT
ASSA ABLOY

Information

This elegant trim by SARGENT seamlessly unifies the lever and the door. Compatible with most Studio Collection and Coastal Series decorative levers, Simpli creates a flawless aesthetic vision on any door opening.

Simpli is offered on the R8200 Series mortise lock, which was specially designed to accept the roseless trim. In addition to the R8200 Series, Simpli is also available with the RDL Series tubular locks and Harmony R8200 Series mortise locks.

- Certified to and exceeds ANSI/BHMA A156.13, Series 1000, Operational Grade 1 and Security Grade 1
- Offered with most 8200 functions
- Available with Coastal Series and many Studio Collection levers (except MC, MK, MN, MP, MT, Gramercy Series, Wooster Square, Grant Park, and Berlin)
- Simpli roseless trim is not compatible with the 8200 lockbody; can only be used with R8200 locks
- All standard cylinder options are available
- Patent pending and/or patent www.assaabloydss.com/patents

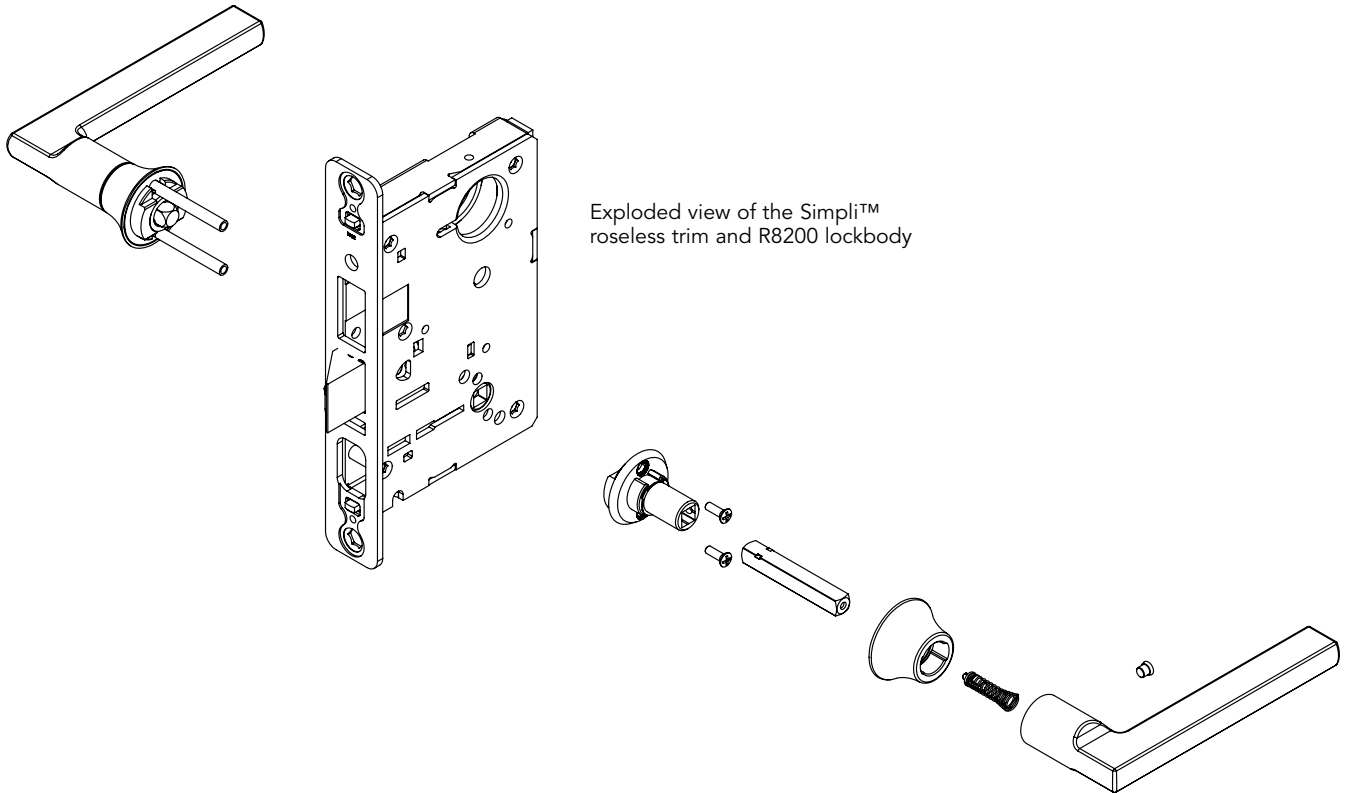

Exploded view of the Simpli™ roseless trim and R8200 lockbody

Simpli™ Collar

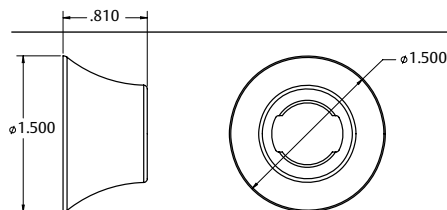

Studio Collection Levers

8200/R8200 Series Mortise Locks

SARGENT
ASSA ABLOY

Studio Collection trim is available in a broad array of designs and finishes. It allows for uniformity throughout a facility using the 8200, R8200 and 7900 Series Mortise Locks, Access Control Products, 80 Series Exit Devices, DL and RDL Series Tubular Locks.

All levers meet ADA compliance for national codes. Visit the online Decorative Hardware Product Selector at selector.sargentlock.com to mix and match styles and finishes.

Centro Series



MC^{2,3}



MD



MJ



MP^{2,3}



ND¹



NJ¹

Notting Hill Series

(MA & MO are Non-Handed Levers)



MA³



MQ³



MT^{2,3}



MM³



MY^{1,3}



MO³



MZ^{1,3}

Aventura Series



MB



ME



MF



NF¹



MG



MI



MW¹

Copyright © 2004-2021, SARGENT Manufacturing Company. All rights reserved. Reproduction in whole or in part without the express written permission of SARGENT Manufacturing Company is prohibited. Patent pending and/or patent www.assaabloy.com/patents.

¹ Lever returns within 1/2" (13mm) of door face

² Levers are not available with Simpli™ Roseless trim

³ Not available in 32D or 32 finish









Studio Collection Levers

8200/R8200 Series Mortise Locks







SARGENT
ASSA ABLOY

Odéon Series





(Handed Levers)

	MN ^{2,5}
	MH ⁵
	MK ^{2,5}
	MS ⁵
	MU ⁵
	MV ⁵
	MX ^{1,5}
	NS ^{1,5}
	NU ^{1,5}







Gramercy Series^{2/3}

	RCM
	RAL
	REM
	RAM
	RAS
	RAG
	RGM

Berlin Series²

	H015
	H016 ¹
	H017
	H018

Wooster Square^{2/4}

	H001
	H002 ¹
	H003
	H004
	H005 ¹
	H006 ¹

Grant Park² (H008 Lever is Handed)

	H007
	H008
	H009
	H010
	H011

¹ Lever returns within 1/2" (13mm) of door face

² Levers are not available with Simpli™ Roseless trim

³ Gramercy levers are customized. See page 50 for ordering information

⁴ H003-H006 - Contain white or black polycarbonate inserts. Not available with MicroShield® antimicrobial coating.

⁵ Not available in 32D or 32 finish

Copyright © 2004-2021, SARGENT Manufacturing Company. All rights reserved. Reproduction in whole or in part without the express written permission of SARGENT Manufacturing Company is prohibited. Patent pending and/or patent www.assaabloydss.com/patents.

Studio Collection Trim

8200 Series Mortise Locks

SARGENT
ASSA ABLOY

Roses (8200 Series)

O Rose

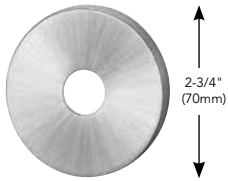

CO Rose

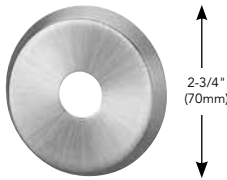

TO Rose

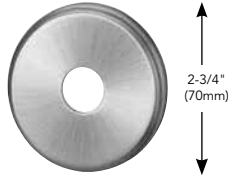

E2 Rose¹

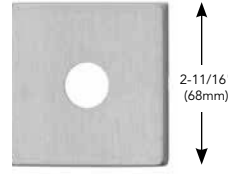

E4 Rose¹

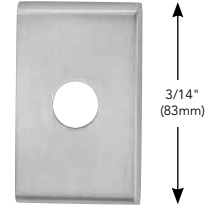

LN Rose

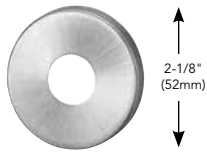

CR Rose

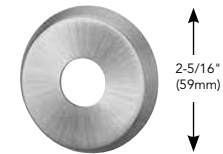

TR Rose



E3 Rose¹

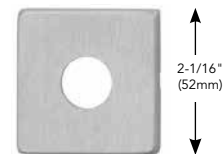

Thumbturns (8200 & R8200 Series)

Thumbturn backplate will match rose design chosen.

Simpli™ Roseless Collar (R8200 Series)

T1 Turn

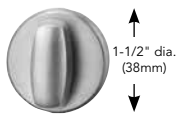

T2 Turn



T3 Turn

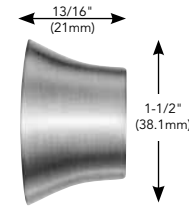
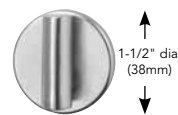

Escutcheons (8200 Series)

LE1 Escutcheon

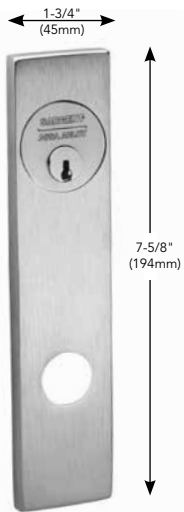

CE Escutcheon

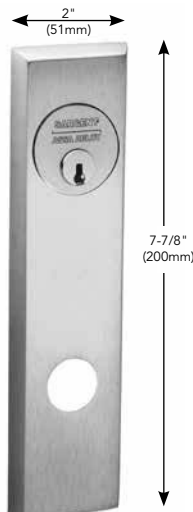

TE Escutcheon

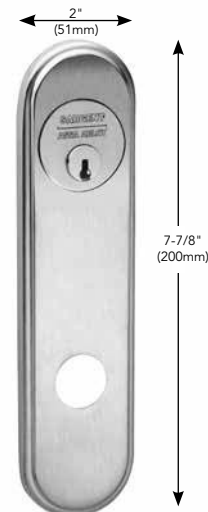

¹ 1KA square cylinder collar and 130KA square backplate automatically supplied with E2, E3 and E4 roses.

Copyright © 2004-2021, SARGENT Manufacturing Company. All rights reserved. Reproduction in whole or in part without the express written permission of SARGENT Manufacturing Company is prohibited. Patent pending and/or patent www.assaabloy.com/patents.

Coastal Series™ Levers, Roses & Escutcheons

8200/R8200/7800 Series Mortise Locks

Coastal Series (8200 & R8200 Series)

Features

- All levers meet ADA compliance for national codes
- Not available with CO and TO roses
- Levers are solid cast brass
- Finishes available – 3, 4, 9, 10, 10B, 10BE, 10BL, 14, 15, 20D, 26, 26D, BSP, WSP
- All lever height (+/- 1/16") measurements represent total distance from door face

<p>G - Gulfport™ (Handed)</p>			<p>S - Sanibel™ (Handed)</p>		
<p>R - Rockport™</p>			<p>Y - Yarmouth™ (Handed)</p>		

TR Traditional Rose

- Dual radii edge

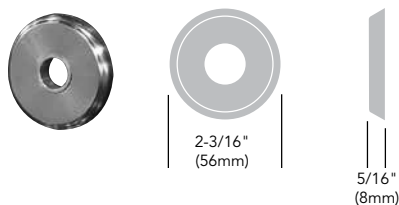

CR Contemporary Rose

- Beveled edge

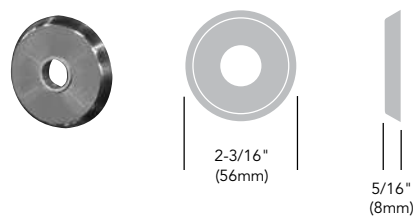

TE Traditional Escutcheon

- Dual radii edge

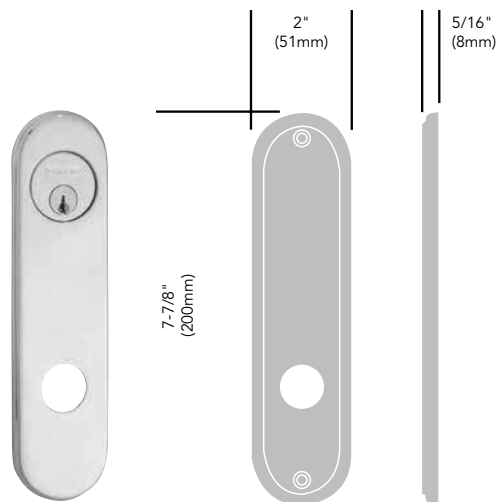

CE Contemporary Escutcheon

- Beveled edge

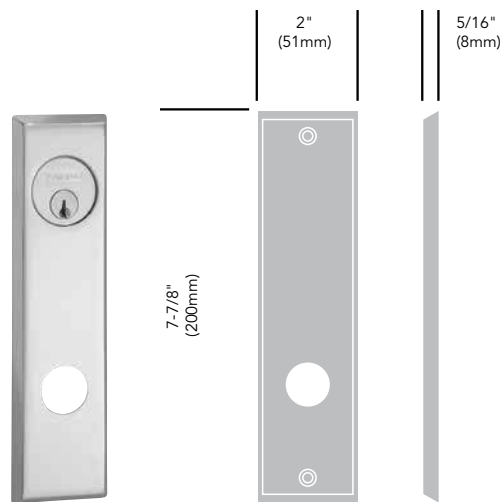

Standard Levers

8200 Series Mortise Locks



Standard Levers (8200 Series Only)

Features

- All levers meet ADA compliance for national codes
- Solid forged or cast
- Lever designs J, L and P have lever returns within 1/2" (13mm) or less of door face and meet California State Reference Fire Code
- All lever height (+/- 1/16") measurements represent total distance from door face

<p>A (Handed)</p>			<p>J</p>		
<p>B</p>			<p>L</p>		
<p>E</p>			<p>P</p>		
<p>F</p>			<p>W</p>		

Standard Roses

L Rose



O Rose



E Rose



LN Rose

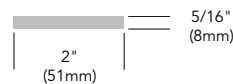

Copyright © 2004-2021, SARGENT Manufacturing Company. All rights reserved. Reproduction in whole or in part without the express written permission of SARGENT Manufacturing Company is prohibited. Patent pending and/or patent www.assaabloydss.com/patents.

Escutcheon Designs

8200/R8200/7800 Series Mortise Locks

Cylinders will protrude from escutcheon face on double cylinder functions only.

LE1/LE2 Escutcheon Design

- Escutcheon: LE-Cast
- LE1- (2) Exposed screws inside
- LE2- (2) Concealed screws inside
- LE1 is available with standard, Coastal & Studio Levers
- LE2 is available with standard levers only

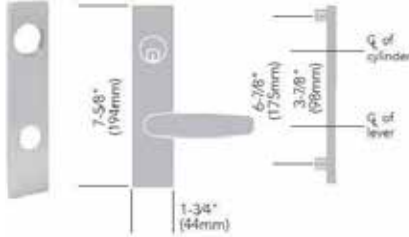

LE3/LE4 Escutcheon Design

- Concealed Cylinder designed Escutcheon, Exposed Barrel Only
- Escutcheon: LE-Cast
- LE3- (2) Exposed screws inside
- LE4- (2) Concealed screws inside
- Not available on double cylinder functions
- Only available with #41 size cylinders - limited keyway and key system offerings – see cylinders section
- If cylinder is ordered separately: specify 78- for concealed cylinder
- LE3 & LE4 are available with standard levers only
- UL437 not available
- Not available with DG2 & DG3 cylinders

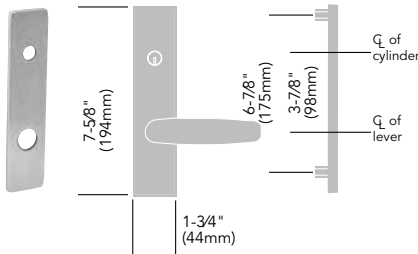

LW1 Escutcheon Design

- Escutcheon: LW1-Wrought
- (2) Exposed screws inside
- LW1 is available with standard levers only

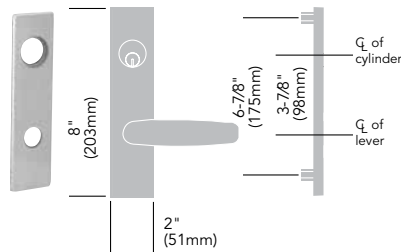

LS Escutcheon Design

- Escutcheon: LS-Forged
- Security Trim: Cylinder is protected by the Escutcheon
- (4) Spanner security screws are exposed on inside trim standard
- LS is available with standard levers only

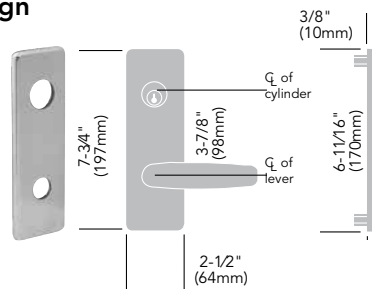

Note: The LS Escutcheon is not available with cylinder options: 10-63-, 11-60-, 11-63-, 11-64-, 60-, 63-, 64-, 70-, 72-, 73-, 65-73-, 65-73-7P-, 73-7P-, 81-, 82-, 83-, 84-, F1-82-, F1-82- & F1-83-. Also not available with electrified functions: 70, 71, 72, 73

VN1 Escutcheon Design

- Escutcheon: Forged
- Thurbolt mounting screws (2)
- Exposed screws inside
- Used only with indicator options
- Refer to page 34

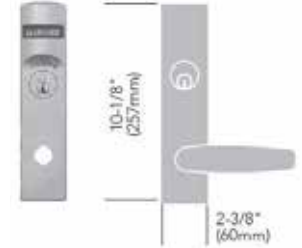

WT Escutcheon Design

- Escutcheon: WT-Heavy wrought
- Surface mounted both inside and outside
- (4) Exposed screws both inside and outside
- WT is available with standard levers only

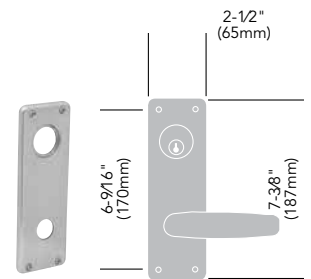

SARGuide™ 8200 Mortise Lock (TL- Option)

- Escutcheon: TL-WT Heavy wrought
- Surface mounted both inside and outside
- (4) Exposed screws both inside and outside
- SARGuide opening 2" x 3/4"
- TL-WT is available with standard levers only



Note: SARGuide is only available with TL- WT Escutcheon.

SARGuide™, with integrated electroluminescent "EXIT" signage, addresses the increasing concern about safe public egress, particularly in low-visibility conditions. SARGuide™ can be wired for continuous operation or for operation only when an emergency alarm is activated.

Mortise Features

- Lamp can be used on internal trim (for external trim, consult factory)
- Includes all features of the 8200 Mortise Lock
- Available with WT escutcheon design only and all standard lever designs. Must specify TL- Option when ordering

SARGuide™ Features

- Illuminated utilizing the patented FLATLITE® electroluminescent lamp embedded within the mortise lock escutcheon
- Dual voltage: 24VAC or VDC input with battery back-up
- Lamp replacement kit available

Freewheeling (FE) Trim Design

8200 Series Mortise Locks

SARGENT
ASSA ABLOY

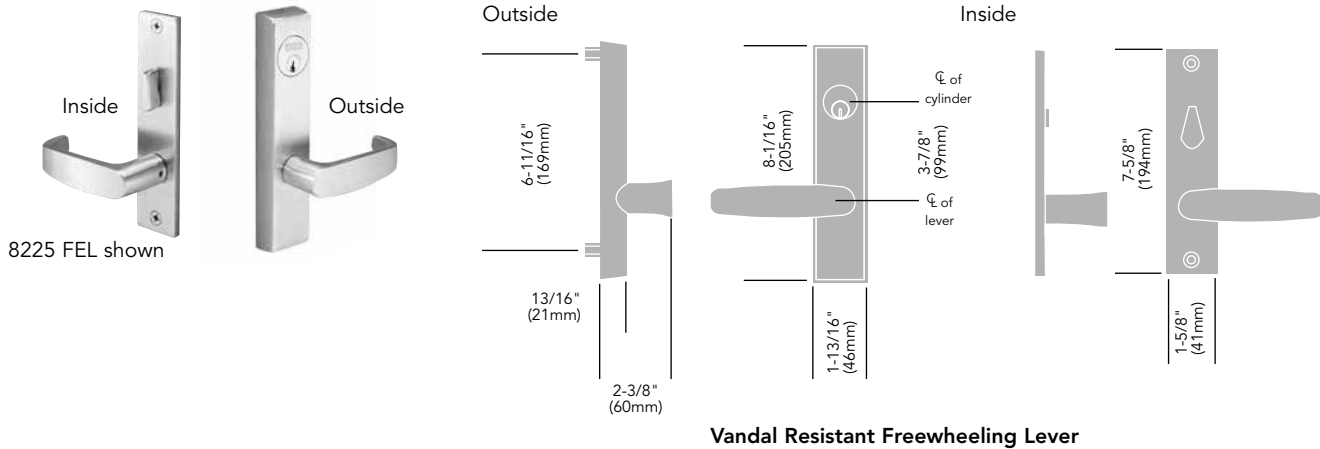

Vandal Resistant Freewheeling Lever

Note: Maximum projection varies by lever design. Largest projection is "A" lever – 3-9/16" (90mm)

Features

The Freewheeling Mortise Trim is designed for areas that are susceptible to vandalism including schools, universities, public buildings, back doors of businesses and any exterior doors where excessive or abusive force might be applied to the lever handle trim.

This design allows the outside lever handle to swing freely, down to 70°, in the "locked" mode. This eliminates resetting the trim after vandalism attempts because the lever automatically returns to its original position.

- For 1-3/4" (44mm) doors standard. For 2" (51mm) and 2-1/4" (57mm) thick doors, must specify door thickness on order
- Vandal resistant trim
- Meets or exceeds ANSI/BHMA A156.13 Series 1000 Operational Grade 1 and Security Grade 1. LFIC (Removable) and SFIC cylinders do not meet Security Grade 1
- Forged brass outside escutcheon trim provides added protection against vandalism (32 and 32D finishes not available)
- Stainless steel lever bushing protects against wear
- Stainless steel lugs and through-bolted trim design for proper alignment and increased security
- Functions available — 04, 05, 16, 17, 24, 25, 26, 31, 35, 36, 37, 38, 39, 40, 51, 65, 66
- Levers A, B, E, F, J, L, P, W available
- Lever designs J, L and P have lever returns within 1/2" (13mm)
- Cylinder will protrude from escutcheon face on double cylinder functions only
- Cylinder sizes #46 (1-3/4") outside, #41 (1-1/8") inside standard on 1-3/4" (44mm) doors
- Specify hand. Easily field rehanded
- Patent pending and/or patent www.assaabloydss.com/patents
- Options available: 3-, 10-, 11-, 11-60-*, 11-63-*, 11-64-*, 11-70-7P-*, 11-72-7P-*, 11-73-7P-*, 11-65-73-7P-*, 21-, 23-, 36-, 37-, 60-*, 63-*, 64-*, 70-*, 72-*, 73-*, 65-73-*, 65-73-7P-*, 73-7P-*, 74-, 75-, 76-, 77-, 82-, SG- & WBS-
- * Can not be used as the inside cylinder with freewheeling trim (#41 cylinder required)

7800 Knob & Rose Designs

7800 Series Mortise Locks

- Knob designs only are available with standard roses (E, L, LN, & O) and escutcheons (KE1/KE2, KE3/KE4, KW1, & WT).
- Available with VN1 escutcheon for V series indicator options only. See page 16.

C Knob Design

- Knob: C-Wrought

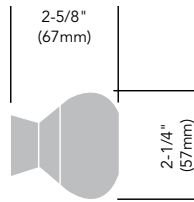

BH Rose

- Available with D Knob only
Must be ordered as BHD Trim

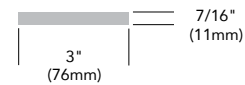

B Knob Design

- Knob: B-Wrought

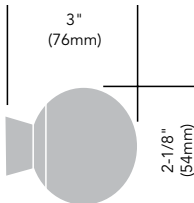

SL Rose

- For Detention Knob x lever or knob, please consult factory

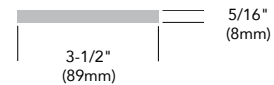

K Knob Design

- Knob: K-Cast
(prior designation 1485)
Only with KS escutcheon

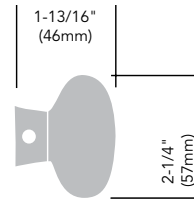

D Knob

- Machined from Stainless Steel
- Only available with BH or SL Rose
- Finish: 32D
- Options not available: 75, 76, 77, 85, 86 & 87

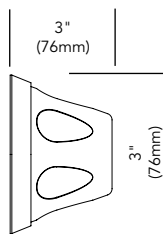

7800 Series Escutcheon Designs

7800 Series Mortise Locks



KW1 Escutcheon Design

- Escutcheon: KW1-Wrought
- (2) Exposed screws inside
- Available with B & C knobs only

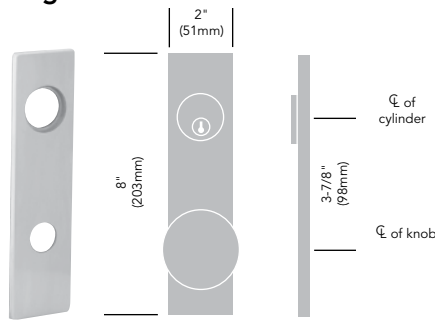

KS Escutcheon Design**

- Security Trim: cylinder is protected by escutcheon
- Escutcheon: KS-Forged
- (4) Spanner screws are exposed on inside trim
- All functions will have escutcheons both sides
- Available with K knob only

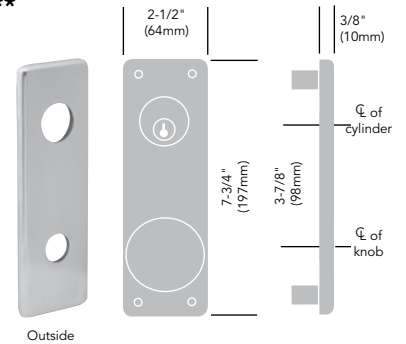

WT Escutcheon Design

- Escutcheon: WT-Heavy wrought
- Surface mounted
- (4) Exposed screws inside and outside
- Available with B & C knobs only

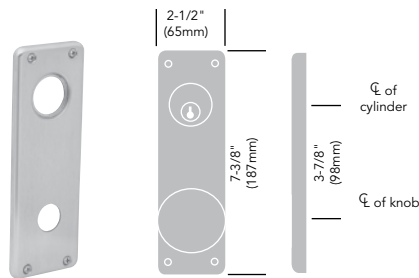

KE3/KE4 Escutcheon Design

- Concealed Cylinder designed Escutcheon, Exposed Barrel Only
- Escutcheon: KE3-Cast
- KE3- (2) Exposed screws inside
- KE4- (2) Concealed screws inside
- Not available on double cylinder functions
- Only available with #41 size cylinders – limited keyway and key system offerings — see cylinders section
- If cylinder is ordered separately: specify 78- for concealed cylinder
- Available with B & C knobs only
- UL437 not available
- Not available with DG2 & DG3 cylinders

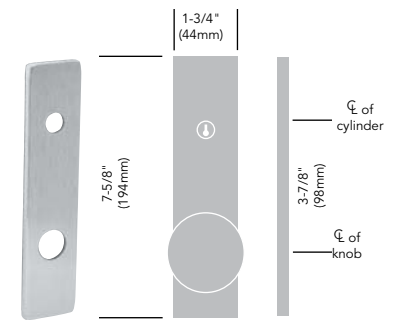

VN1 Escutcheon Design

- Thrubolt mounting screws (2)
- Exposed screws inside
- Available with B knobs only
- Refer to page 34

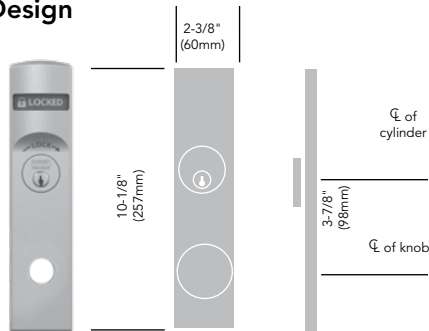

KE1/KE2 Escutcheon Design

- Escutcheon: KE1-Cast
- KE1- (2) Exposed screws inside
- KE2- (2) Concealed screws inside
- Available with B & C knobs only

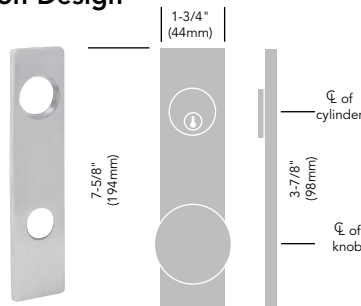

** KS Escutcheon is not available with cylinder options: 10-63-, 11-60-, 11-63-, 11-64-, 60-, 63-, 64-, 70-, 72-, 73-, 65-73-, 65-73-7P-, 73-7P-, 81-, 82-, 83-, 84-, F1-82-, F1-82- & F1-83-. Also not available with electrified functions: 70, 71, 72, 73

Copyright © 2004-2021, SARGENT Manufacturing Company. All rights reserved. Reproduction in whole or in part without the express written permission of SARGENT Manufacturing Company is prohibited. Patent pending and/or patent www.assaabloydss.com/patents.

Behavioral Health Series™ Trim

SARGENT
ASSA ABLOY

8200 Series Mortise Locks

8200 Push/Pull Trim (ALP)



(Paddle shown horizontally)

The 8200 mortise lock with push/pull trim provides an aesthetically-pleasing alternative to standard push/pull products. Ease of operation, along with the strength, versatility and integrity of the 8200 mortise lock, allows its use in many types of environments. Perfect for health care facilities, including behavioral health units, patient room doors and operating rooms.

Features

- Paddles can be mounted in vertically (up or down) and horizontally (towards hinge) – with Cylinder - paddle mounts vertically down or horizontally
- Easy installation
- Trim is non-handed; lockbody is easily field reversible
- Through-bolted trim for stability
- Torx® and spanner screws optional with ALP
- Lead lining is optional (Lockbody only), specify 74- option
- Covers are cast stainless steel
- Paddles are cast stainless steel
- Finish: 32D
- Patent pending and/or patent www.assaabloydss.com/patents

See Healthcare Hardware Catalog 90712 for more details

8200 Series with BHW* Trim



Part of the Behavioral Health Series™ of products, the 8200 mortise lock with BHW trim provides an innovative solution for behavioral health environments. The unique integrated lever and escutcheon combines aesthetics with safety. Ease of operation, along with the strength and versatility of the 8200 mortise lock allows its use in many applications.

Features

- Available in 40 functions
- Uses standard mortise prep
- ANSI/BHMA Grade 1
- Tapered surfaces on all components
- Handed
- Available with MicroShield® antimicrobial coating
- Trim only option available with existing sectional and escutcheon trim only
- Trim only kits
 - 694-1 Trim only, non-keyed functions
 - 694-2 Trim only, single cylinder functions
 - 694-3 Trim only, double cylinder functions

- ADA Compliant
- Matching thumbturn available
- Finish: 32D
- 6 Lobe head security screws (Torx® type)
- Patent pending and/or patent www.assaabloydss.com/patents

See Healthcare Hardware Catalog 90712 for more details

8200 with BHL* Trim



The SARGENT BHL trim is part of the Behavioral Health Series™ of products. With an array of functions, this trim can be used on virtually any opening in healthcare applications. Sloping surfaces and overlapping rose and lever address safety concerns common in behavioral health. Optimal for tough environments, the SARGENT 8200 mortise lock provides impressive strength and reliability.

Features

- Available in 41 functions
- UL Fire Rated
- ANSI/BHMA Grade 1
- Outside and inside levers will freely rotate up and down 45° when in the locked condition.
- Sloped surfaces
- Non-Handed
- Concealed hardware
- Overlapping lever and rose construction
- ADA compliant
- Finish: 32D
- Available with MicroShield® antimicrobial coating

See Healthcare Hardware Catalog 90712 for more details

* Although these products are better designed for behavioral health applications than traditional trim, they do not eliminate the risk that an object can be affixed to, or around them

PT Push/Pull Trims & Anti-Vandal Option

8200/7800 Series Mortise Locks

SARGENT
ASSA ABLOY

7800 Push/Pull Trim (PT)



(Paddle shown horizontally)

Typically used in the healthcare environment, push/pull trim is known for its ease of operation. Because the mortise lock with trim is more durable and secure than a cylindrical lock, conference rooms, handicapped restrooms, laboratories and pharmacies are appropriate applications.

Features

- Paddles can be mounted in vertically (up or down) and horizontally (towards hinge)
 - with Cylinder — paddle mounts vertically down or horizontally
 - with thumb turn — paddle mounts horizontally only
- Paddles & Covers are cast stainless steel, brass or bronze
- Handing is easily field reversible
- Through-bolted trim for stability
- Functions available: 04, 15, 16, 17, 24, 26, 37, 43, 45, 50, 65

See Healthcare Hardware Catalog 90712 for more details

7800/8200 Anti-Vandal Trim (AV)

Designed for exterior doors that require extra security or resistance to vandalism. AV anti-vandal trim plates have an extended lip on the active side of the door to provide extra protection for the latchbolt, deadbolt and deadlatch. A matte plastic coated grip edge provides a comfortable pull that feels good over wide temperature ranges. Fully through-bolted without exposed exterior fasteners for a clean look and increased security.

Features

- Heavy duty 12 gauge stainless steel in 32D finish only
- Through-bolted through mortise lockbody and door for added strength
- Handed: specify RHRB or LHRB
- ADA Compliant
- Patent Pending
- Available with all inside trim except LS/KS, FE and PT
- Options not available with AV trim: 1-, 31-, 49-, 50-, 68-, 69, 76, 77-, 85, 86, 87, DX- & SG-
- See chart to right for available functions
- For inactive door, available without protective lip
- Anti-Vandal Trim is available as a retrofit (667- Kit) or with the lock, as an "AV" option

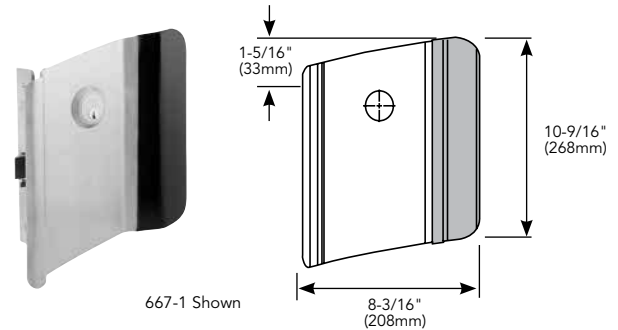

667-1 Shown

667 AV Retrofit Kit

Retrofit kits for 7800, 7900, 8200 & 9200 mortise locks 667 Kit includes:

- AV Pull
- 1SB Rosette
- (4) 1/4-20 screws
- Instructions & Templates
- (4) Cup washers

RHRB	LHRB	Functions
667-1 82-4034	667-2 82-4035	04, 06, 17, 28, 29, 30, 50, 51, 52, 91 & 92 -1 & -2 Trim has an extended lip, cylinder hole and through-bolt post for mounting Inside trim
667-3* 82-4036	667-4* 82-4037	03, 20, 21, 23, & 31 -3 & -4 Trim has an extended lip & cylinder hole for deadbolt functions only
667-5* 82-4044	667-6* 82-4045	-5 & -6 Trim is designed as a Pull does not have an extended lip or cylinder hole

* For Deadbolt Functions only without lever trim

Copyright © 2004-2021, SARGENT Manufacturing Company. All rights reserved. Reproduction in whole or in part without the express written permission of SARGENT Manufacturing Company is prohibited. Patent pending and/or patent www.assaabloy.com/patents.

Functions & Descriptions

8200/R8200/7800 Series Mortise Locks

Single Cylinder without Deadbolt

*±04 Storeroom or Closet

8200, R8200 & 7800

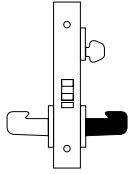

- Key outside retracts latchbolt
- Trim outside locked at all times
- Trim inside always retracts latchbolt
- Auxiliary deadlatch
- A Multi-Function 8200/R8200/7800 Lockbody
- **ANSI F07**

◊*31 Utility

8200, R8200 & 7800

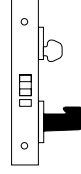

- Key outside retracts latchbolt
- Trim outside is always locked
- No inside trim or cylinder
- A Multi-Function 8200/R8200/7800 Lockbody
- Auxiliary deadlatch

*05 Office or Entry

8200, R8200 & 7800

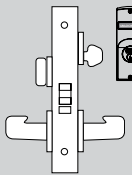

- Key outside retracts latchbolt, also locks & unlocks outside trim
- Trim inside always retracts latchbolt, trim outside remains locked
- Thumbturn inside locks & unlocks outside trim
- Auxiliary deadlatch
- A Multi-Function 8200/R8200/7800 Lockbody
- **ANSI F04**

The Multi-Function Advantage with rose trim:

1. Lock will accommodate 04, 05, 15 & 37 functions without additional parts.
2. By adding an additional cylinder, lock will accommodate 38 function.
3. By adding a Trim One Side Kit, lock will accommodate 06, 13, 31 & 36 functions.

NOTE: Office/Entry Function with toggle is a 55 function.

*◊36 Closet

8200, R8200 & 7800

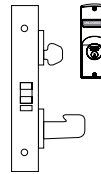

- Key locks and unlocks trim
- No inside trim or cylinder
- A Multi-Function 8200/R8200/7800 Lockbody
- Auxiliary dead latch

*±37 Classroom

8200, R8200 & 7800

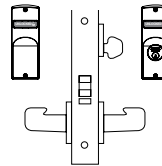

- Key outside retracts latchbolt, also locks & unlocks outside trim
- Trim inside always retracts latchbolt
- Auxiliary deadlatch
- A Multi-Function 8200/R8200/7800 Lockbody
- **ANSI F05**

06 Storeroom or Service

8200, R8200 & 7800

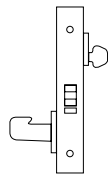

- No trim outside, cylinder only
- Key outside retracts latchbolt
- Trim inside always retracts latchbolt
- Auxiliary deadlatch
- A Multi-Function 8200/R8200/7800 Lockbody
- Same as 04 Function without trim outside

55 Office or Entry

8200, R8200 & 7800

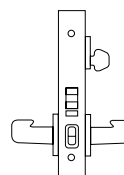

- Key outside retracts latchbolt
- Trim inside always retracts latchbolt, outside trim remains locked
- Trim outside is locked & unlocked by the toggle only
- Auxiliary deadlatch

*8200 Available with Freewheeling Trim

±7800 Available with Push/Pull Trim



If shaded, knob or lever rigid at all times



Indicator options available for both sectional and escutcheon trim.

◊**CAUTION:** Not recommended for use on any door used for Life Safety egress

Functions & Descriptions

8200/R8200/7800 Series Mortise Locks

SARGENT
ASSA ABLOY

Single Cylinder without Deadbolt

56 Office & Inner Entry Lock

8200, R8200 & 7800

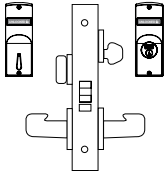

- Key outside retracts latchbolt
- Trim inside always retracts latchbolt and unlocks outside trim
- Trim outside is locked by thumbturn or key
- Auxiliary deadlatch

67 Institutional Privacy

8200, R8200 & 7800

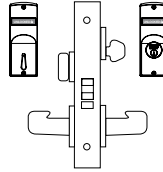

- Key outside retracts latchbolt, overriding thumbturn when held in locked position
- Thumbturn inside locks & unlocks outside trim
- Trim outside unlocks when the door closes or operating trim inside
- Trim inside always retracts latchbolt
- Auxiliary deadlatch
- **ANSI F26**

Note: Key does not lock trim outside, only unlocks it

57 Institutional Privacy

8200, R8200, 7800

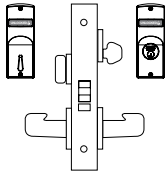

- Key outside retracts latchbolt, overriding thumbturn when held in locked position
- Thumbturn inside locks & unlocks outside trim
- Trim outside unlocks when the door closes or operating trim inside
- Trim inside always retracts latchbolt
- Auxiliary deadlatch

Note: Key locks & unlocks trim outside

89 Holdback

8200

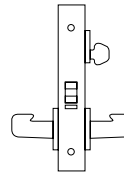

- Key outside retracts latchbolt, also locks & unlocks outside trim
- Trim inside always retracts latchbolt
- Auxiliary deadlatch
- Latch holdback — to set, rotating & hold lever, then rotate key twice toward latchbolt. Lever will remain in rotated position indicating it is unlocked
- **ANSI F06**

58 Institutional Privacy

8200, R8200, 7800

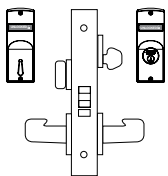

- Key outside retracts latchbolt, overriding thumbturn when held in locked position
- Thumbturn inside locks & unlocks outside trim
- Trim outside does not unlock when the door closes
- Trim outside unlocks when operating trim inside
- Trim inside always retracts latchbolt
- Auxiliary deadlatch

Note: Key locks & unlocks trim outside

91 All Purpose Holdback

8200

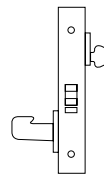

- Key outside retracts latchbolt
- Key outside can lock latchbolt in retracted position
- Trim inside always retracts latchbolt
- No outside trim
- Auxiliary deadlatch
- Latch holdback — set by rotating & holding trim, then rotate key toward latchbolt. Lever will remain in rotated position for unlocked indication

Copyright © 2004-2021, SARGENT Manufacturing Company. All rights reserved. Reproduction in whole or in part without the express written permission of SARGENT Manufacturing Company is prohibited. Patent pending and/or patent www.assaabloy.com/patents.

 Indicator options available for both sectional and escutcheon trim.

Functions & Descriptions

8200/R8200/7800 Series Mortise Locks

Single Cylinder with Deadbolt

◊*‡24 Room Door

8200, R8200 & 7800

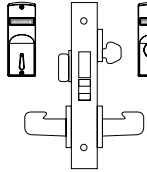

- Key outside or thumbturn inside retracts and projects deadbolt
- Trim either side retracts latchbolt
- Latchbolt & deadbolt operate independently of each other
- **ANSI F21**

30 Dummy Trim Deadlock

8200, R8200 & 7800

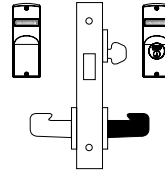

- Deadbolt operation only
 - Key outside retracts and projects deadbolt
 - Trim inside always retracts deadbolt
 - Trim outside is always locked
 - Same as 28 Function without a thumbturn
- Note: Indicator shows deadbolt position only

*25 Dormitory or Exit

8200, R8200 & 7800

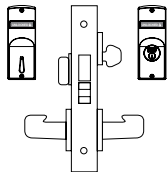

- Key outside or thumbturn inside retracts and projects deadbolt
- Trim from either side retracts latchbolt, when the deadbolt is in the retracted position
- Trim outside is locked, when the deadbolt is projected
- When deadbolt is projected, Trim inside retracts latchbolt and deadbolt simultaneously, unlocking outside trim
- **ANSI F13**

◊*35 Storeroom

8200, R8200 & 7800

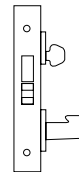

- Key outside retracts and projects deadbolt
- Trim outside retracts latchbolt, except when deadbolt is projected
- No inside trim or cylinder

◊27 Closet or Storeroom

8200, R8200 & 7800

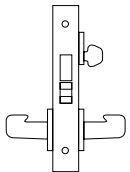

- Key outside retracts and projects deadbolt
- Trim from either side retracts latchbolt
- Same as 24 function without thumbturn
- Latchbolt & deadbolt operate independently of each other

‡43 Apartment Corridor Door

8200, R8200 & 7800

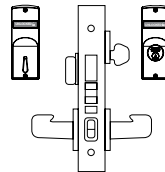

- Key and thumbturn both retract & project the deadbolt
- Trim outside is locked by toggle or projecting deadbolt
- Trim outside is unlocked by toggle only
- Key retracts both latchbolt and deadbolt, trim outside remains locked
- Trim inside always retracts latchbolt (and deadbolt simultaneously), trim outside remains locked
- Auxiliary deadlatch
- **ANSI F20**

28 Dummy Trim Deadlock

8200, R8200 & 7800

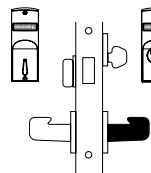

- Deadbolt operation only
 - Key outside retracts and projects deadbolt
 - Trim inside always retracts deadbolt
 - Trim outside is always locked
 - Thumbturn inside retracts and projects deadbolt
- Note: Indicator shows deadbolt position only

*8200 Available with Freewheeling Trim
‡7800 Available with Push/Pull Trim

◊**CAUTION:** Not recommended for use on any door used for Life Safety egress

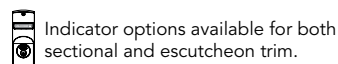
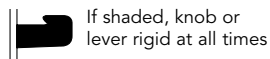

Functions & Descriptions

8200/R8200/7800 Series Mortise Locks



Single Cylinder with Deadbolt

‡45 Dormitory or Exit

8200, R8200 & 7800

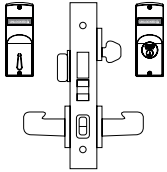

- Key and thumbturn both retract & project deadbolt
- Trim outside is locked by toggle or projecting deadbolt
- Trim outside is unlocked by toggle only
- Key retracts both latchbolt and deadbolt, trim outside remains locked
- Trim inside always retracts latchbolt (and deadbolt simultaneously), trim outside remains locked
- Same as an 8243 without Auxiliary Deadlatch
- **ANSI F12**

Note: Indicator shows deadbolt position only

*‡ 50 Hotel Guest

8200, R8200 & 7800

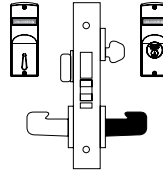

- Hotel Cylinder (50 Function) Required (Standard & Emergency Keys)
- Standard Key retracts latchbolt only, will not retract or project deadbolt
- Emergency Key (ordered separately) will retract latchbolt & deadbolt and also project deadbolt
- Thumbturn retracts & projects deadbolt
- Trim inside retracts latchbolt & deadbolt simultaneously
- Trim outside is always locked
- Auxiliary deadlatch
- Available with Conventional, LFIC (60- & 63-), Degree (60-, 63-, & 64-) and Keso (82- & F1-82-) key systems
- **ANSI F15**

Note: Indicator shows deadbolt position only

◊47 Front Door or Apartment Corridor Door

8200, R8200 & 7800

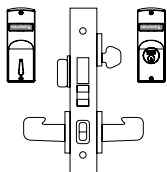

- Key and thumbturn both retract & project deadbolt
- Trim outside is locked by toggle or projecting deadbolt
- Trim outside is unlocked by toggle only
- Key retracts both latchbolt and deadbolt, trim outside remains locked
- Trim inside retracts latchbolt only, deadbolt is retracted manually & trim outside remains locked
- **ANSI F08/F10**

Note: Indicator shows deadbolt position only

*51 Storeroom Deadbolt

8200, R8200 & 7800

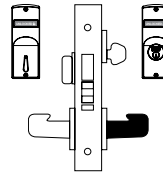

- Key and thumbturn both retract & project the deadbolt
- Key will also retract latchbolt
- Trim inside retracts latchbolt & deadbolt simultaneously
- Trim outside is always locked
- Auxiliary deadlatch
- Same as 50 function with a std. cylinder

Note: Indicator shows deadbolt position only

Copyright © 2004-2021, SARGENT Manufacturing Company. All rights reserved. Reproduction in whole or in part without the express written permission of SARGENT Manufacturing Company is prohibited. Patent pending and/or patent www.assaabloy.com/patents.

*8200 Available with Freewheeling Trim

‡7800 Available with Push/Pull Trim



If shaded, knob or lever rigid at all times



Indicator options available for both sectional and escutcheon trim.

◊**CAUTION:** Not recommended for use on any door used for Life Safety egress

Functions & Descriptions

8200/R8200/7800 Series Mortise Locks

Double Cylinder without Deadbolt

*‡16 Apartment, Exit or Public Restroom

8200, R8200 & 7800

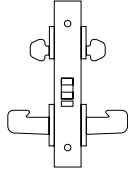

- Key outside retracts latchbolt
- Key inside is required to lock and unlock trim outside
- Trim inside always retracts latchbolt
- Auxiliary deadlatch
- Special -105 cam, required for inside cylinder (supplied)
- **ANSI F09**

◇59 Double Locking

8200 & R8200

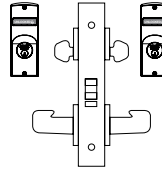

- Key from either side locks & unlocks both the inside & outside trims
- Key from either side retracts latchbolt
- Key from either side can retract latchbolt without unlocking trims
- Auxiliary deadlatch

◇‡17 Asylum or Institutional

8200, R8200 & 7800

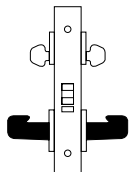

- Key from either side retracts latchbolt
- Trim on both sides are locked at all times
- Auxiliary deadlatch
- **ANSI F30**

90 Classroom Security Holdback

8200

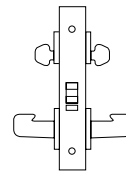

- Key from either side retracts latchbolt, also locks & unlocks outside trim
- Latchbolt can be locked in the retracted position by key from either side
- Trim inside always retracts latchbolt
- Auxiliary deadlatch
- Latch holdback — to set, rotating & hold lever, then rotate key twice toward latchbolt. Lever will remain in rotated position indicating it is unlocked

*38 Classroom Security Intruder Latchbolt

8200, R8200 & 7800

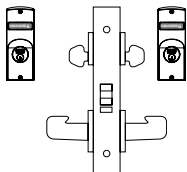

- Key from either side locks & unlocks outside trim
- Key from either side retracts latchbolt
- Trim outside retracts latchbolt, except when locked
- Trim inside always retracts latchbolt
- A Multi-Function 8200/R8200/7800 Lockbody
- Auxiliary deadlatch
- **ANSI F32**

92 All Purpose Holdback

8200 & 7800

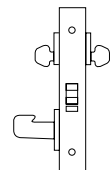

- Key outside retracts latchbolt
- Key inside can lock latchbolt in retracted position when the lever is rotated
- Trim inside always retracts latchbolt
- No outside trim
- Auxiliary deadlatch
- 7892 "T" turn is used in place of knob
- Special -105 cam required for inside cylinder (Supplied Standard)
- Latch holdback — to set, rotating & hold lever, then rotate key twice toward latchbolt. Lever will remain in rotated position indicating it is unlocked

*42 Classroom Security Intruder Latchbolt

8200

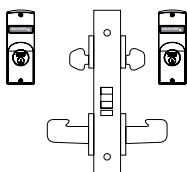



- **Handed function; handing must be specified. This function is NOT field reversible for handing.**
- Key inside only locks outside trim (does not unlock)
- Key outside locks and unlocks outside trim
- Key outside retracts latchbolt
- Trim outside retracts latchbolt, except when locked
- Trim inside always retracts latchbolt
- Auxiliary deadlatch

*8200 Available with Freewheeling Trim

‡7800 Available with Push/Pull Trim

◇CAUTION: Not recommended for use on any door used for Life Safety egress

 If shaded, knob or lever rigid at all times

 Indicator options available for both sectional and escutcheon trim.

Experience a safer
and more open world

1-800-727-5477 • www.sargentlock.com

23

Functions & Descriptions

8200/R8200/7800 Series Mortise Locks

SARGENT
ASSA ABLOY

Double Cylinder with Deadbolt

♦*‡26 Store Door

8200, R8200 & 7800

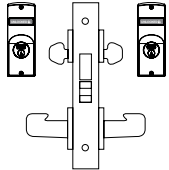

- Key from either side retracts & projects deadbolt
- Trim from either side retracts latchbolt
- Latchbolt and deadbolt are independent of each other
- **ANSI F14**

*40 Classroom Security Intruder Deadbolt

8200, R8200 & 7800

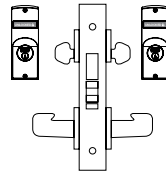

- Key from either side retracts or projects deadbolt which also unlocks or locks outside trim
- Trim outside retracts latchbolt, except when locked
- Trim outside is only locked by projecting the deadbolt
- Trim inside retracts both latchbolt and deadbolt simultaneously, and unlocks outside trim
- Auxiliary deadlatch
- Same as an 8239 with Auxiliary deadlatch
- **ANSI F34**

29 Dummy Trim Deadlock

8200, R8200 & 7800

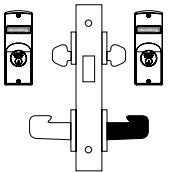

- Deadbolt operation only
 - Key on either side retracts & projects deadbolt
 - Trim inside retracts deadbolt
 - Trim outside is always locked
- Note: Indicator shows deadbolt position only

41 Classroom Security Intruder Deadbolt

8200, R8200 & 7800

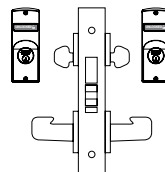

- Key from either side retracts and projects deadbolt
- When deadbolt is projected, 1st key rotation retracts deadbolt, 2nd key rotation unlocks trim outside
- Key retraction of latchbolt from either side unlocks trim outside
- Trim outside retracts latchbolt, except when locked
- Trim inside (when deadbolt is projected) retracts both latchbolt and deadbolt simultaneously and the outside trim remains locked
- Auxiliary deadlatch

*39 Classroom Security Intruder Deadbolt

8200, R8200 & 7800

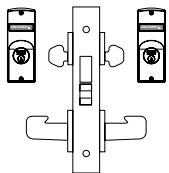

- Key either from side retracts or projects deadbolt which also unlocks or locks outside trim
- Trim outside retracts latchbolt, except when locked
- Trim outside is only locked by projecting the deadbolt
- Trim inside retracts both latchbolt and deadbolt simultaneously, and unlocks outside trim
- **ANSI F33**

46 Dormitory or Exit

8200, R8200 & 7800

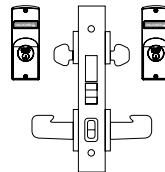

- Key from either side retracts and projects deadbolt
- Key from either side retracts both latchbolt and deadbolt, trim outside remains locked
- Trim outside is locked by toggle or projecting deadbolt
- Trim outside is unlocked by toggle only
- Trim inside (when deadbolt is projected) retracts both latchbolt and deadbolt simultaneously and the outside trim remains locked

Note: Indicator shows deadbolt position only

Copyright © 2004-2021, SARGENT Manufacturing Company. All rights reserved. Reproduction in whole or in part without the express written permission of SARGENT Manufacturing Company is prohibited. Patent pending and/or patent www.assaabloydss.com/patents.

*8200 Available with Freewheeling Trim

‡7800 Available with Push/Pull Trim



If shaded, knob or lever rigid at all times



Indicator options available for both sectional and escutcheon trim.

♦**CAUTION:** Not recommended for use on any door used for Life Safety egress

Functions & Descriptions

8200/R8200/7800 Series Mortise Locks

Double Cylinder with Deadbolt

◊48 Store Door

8200, R8200 & 7800

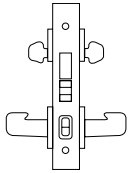

- Key from either side retracts and projects deadbolt
- Key from either side retracts latchbolt
- Trim outside is locked by toggle or projecting deadbolt and unlocked by toggle only
- Trim inside (when deadbolt is projected) retracts latchbolt only, and outside trim remains locked
- **ANSI F25**

◊49 Security Deadbolt

8200 & R8200

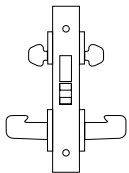

- Key from either side retracts and projects deadbolt
- Key from either side retracts latchbolt
- Trim inside & outside are locked only when deadbolt is projected

◊52 Institutional Deadbolt

8200, R8200 & 7800

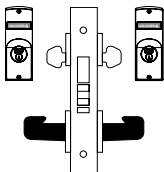

- Key from either side retracts and projects deadbolt
- Key from either side retracts latchbolt
- Trim inside and out are always locked
- Auxiliary deadlatch

Note: Indicator shows deadbolt position only



If shaded, knob or lever rigid at all times



Indicator options available for both sectional and escutcheon trim.

◊**CAUTION:** Not recommended for use on any door used for Life Safety egress

Functions & Descriptions

8200/R8200/7800 Series Mortise Locks

SARGENT
ASSA ABLOY

Non-Keyed

12 Passage with Indicator

8200 & 7800

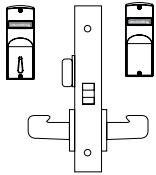

- For doors with indicator that do not require locking
- Latchbolt retracted by trim either side at all times
- Throwing thumbturn on inside changes state of status indicator
- Rotating either trim returns indicator to previous state

Note: Only available with "V" series indicators. Indicator option code must be specified with this function

13 Exit Latch

8200, R8200 & 7800

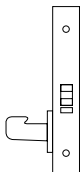

- No outside trim or cylinder
- Trim inside retracts latchbolt
- A Multi-Function 8200/R8200/7800 Lockbody
- Auxiliary deadlatch
- **ANSI F31**

‡15 Passage or Closet

8200, R8200 & 7800

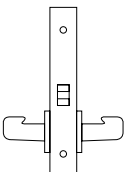

- Trim from either side retracts latchbolt at all times
- **ANSI F01**

*‡ 65 Privacy Bath/Bedroom

8200, R8200 & 7800

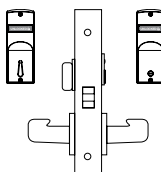

- Trim outside retracts latchbolt except when locked by thumbturn
- Trim inside retracts latchbolt and unlocks outside trim
- Emergency Release locks/unlocks trim outside-by coin, screwdriver or Emergency key (14-0057) ordered separately
- Thumbturn locks and unlocks trim outside
- Closing the door will unlock outside trim
- **ANSI F22**

*66 Privacy Bath/Bedroom

8200, R8200 & 7800

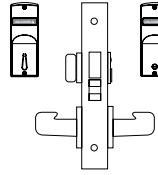

- Trim outside retracts latchbolt except when deadbolt is projected
- Trim inside retracts both latchbolt and deadbolt simultaneously, unlocking the outside trim
- Emergency Release retracts and projects deadbolt — by coin, screw driver or Emergency key (14-0057) ordered separately
- Thumbturn retracts and projects deadbolt
- **ANSI F19**

◊68 Privacy Bath/Bedroom

8200, R8200 & 7800

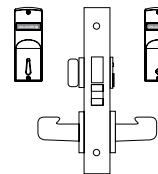

- Trim from either side retracts latchbolt at all times
- Thumbturn retracts and projects deadbolt
- Emergency release retracts and projects deadbolt — by coin, screwdriver or Emergency key (14-0057) ordered separately
- Latchbolt and deadbolt are independent of each other
- **ANSI F02**

93 Trim Dummy

8200, R8200 & 7800

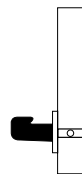

- Trim on inside of door is always rigid
- Trim only used as door pull
- For double door applications, installed on the inactive door, use template #4298 to accept latchbolt from active door

Note: Lever is through-bolted

*8200 Available with Freewheeling Trim

‡7800 Available with Push/Pull Trim



If shaded, knob or lever rigid at all times



Indicator options available for both sectional and escutcheon trim.

◊**CAUTION:** Not recommended for use on any door used for Life Safety egress

Copyright © 2004-2021, SARGENT Manufacturing Company. All rights reserved. Reproduction in whole or in part without the express written permission of SARGENT Manufacturing Company is prohibited. Patent pending and/or patent www.assaabloydss.com/patents.

90115 10/21

Functions & Descriptions

8200/R8200/7800 Series Mortise Locks

Non-Keyed

94 Trim Dummy

8200, R8200 & 7800

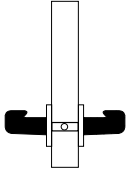

- Trim on both sides are always rigid
- Trim only used as door pull
- Recommended for double door applications on the inactive door, use template #4298, to accept latchbolt from active door

Note: Lever not surface mounted

96 Double Trim Dummy

8200, R8200 & 7800

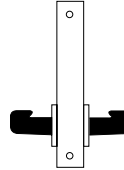

- Trim on both sides of the door
- Both trims are always rigid
- Includes lock case and armor front
- Not recommended on double door applications (will not accept latchbolt from active door)

95 Single Trim Dummy

8200, R8200 & 7800

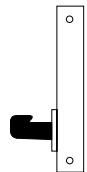

- Trim inside only
- Trim is always rigid
- Includes lock case and armor front
- Not recommended on double door applications (will not accept latchbolt from active door)

97 Active Trim Dummy

8200, R8200 & 7800

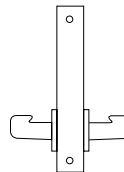

- Trim on both sides are active
- Includes lock case and armor front
- Not recommended on double door applications (will not accept latchbolt from active door)



If shaded, knob or lever rigid at all times

Functions & Descriptions

8200/R8200/7800 Series Mortise Locks

SARGENT
ASSA ABLOY

Deadbolt Only

◇03 Classroom Deadlock

8200

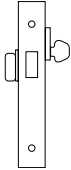

- Deadbolt operation only
- Key outside retracts and projects deadbolt
- Thumbturn inside retracts deadbolt only, will not project it
- **ANSI F29**

◇22 Deadlock

8200

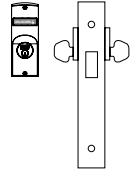

- Deadbolt operation only
- Key outside or inside retracts and projects deadbolt
- **ANSI F16**

◇20 Deadlock

8200

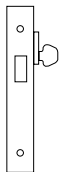

- Deadbolt operation only
- Key outside retracts and projects deadbolt
- No inside operation
- **ANSI F18**

◇23 Classroom Deadlock

8200

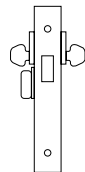

- Deadbolt only operation
- Key outside or inside retracts and projects deadbolt
- Thumbturn inside retracts deadbolt, does not project deadbolt
- Same as 03 function with cylinder inside
- Not Available with Behavioral Health Trim

◇21 Deadlock

8200

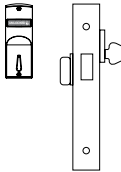

- Deadbolt operation only
- Key outside retracts and projects deadbolt
- Thumbturn inside retracts and projects deadbolt
- **ANSI F17**

Copyright © 2004-2021, SARGENT Manufacturing Company. All rights reserved. Reproduction in whole or in part without the express written permission of SARGENT Manufacturing Company is prohibited. Patent pending and/or patent www.assaabloy.com/patents.



Indicator options available for both sectional and escutcheon trim.

◇**CAUTION:** Not recommended for use on any door used for Life Safety egress

90115 10/21

28

1-800-727-5477 • www.sargentlock.com

Experience a safer
and more open world

Electrical Functions & Monitoring Options

8200/R8200/7800 Series Mortise Locks

SARGENT
ASSA ABLOY

SARGENT 8200 Electromechanical Mortise locks are designed to handle single opening, stand alone applications, or can be readily integrated into sophisticated access control systems. They meet ANSI/BHMA A156.13 Grade 1 requirements, are UL listed on fire doors, and satisfy industry standards for operating temperature, shock and fire hazard.

Featuring EcoFlex®*



- **Reduces energy consumption up to 96%, as certified by GreenCircle**
 - Lower operating costs
 - Assists with load reduction in optimizing energy performance credit in LEED
 - Reduces number of power supplies required
- **Field configurable to fail-safe or fail-secure**
- **Operates from 12-24VDC, offering greater flexibility in system design**
- **Innovative actuator design provides superior reliability**
 - Higher performance and reduced maintenance
 - Ability to have longer cable runs without negatively impacting lock function
 - Reduces risk of voltage drops and eliminates inductive kickback
 - Lower total cost of ownership

*Patent pending and/or patent www.assaabloydss.com/patents

Electrical Requirements for electromechanical functions:

Voltage: Operates from 12-24VDC Regulated. Full wave rectification installed inside the lockbody.

Current:

- Actuator draw = .015 Amp continuous
- Maximum (2) locks per 1 Amp power supply (1/2 Amp peak current draw)

Operating Temp.: Max. 151°F (66°C), Min -31°F (-35°C)

UL and CUL listed for use on Fire Doors

Note: Repeated operation at voltage exceeding +/- 10% is not recommended

Warning:

- **Do not** connect locks to a circuit sharing an additional electromagnetic device as the lock may be damaged
- Transient voltage must be suppressed at the source or before connecting with the lock
- Varistor rated at 35 volts (peak) may be used for transient voltage protection

Note: Opening the lockbody or the actuator replacement in the field by non-authorized personnel voids UL label and lock warranty

Electromechanical Functions

70 Electrical (Fail Safe)

71 Electrical (Fail Secure)

8200 & R8200

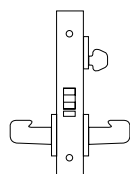

- 70 function — Power ON, locks outside lever
- 71 function — Power ON, unlocks outside lever
- Specify voltage: 12VDC or 24VDC (operates from 12-24VDC)
- Key outside retracts latchbolt
- Lever outside retracts latchbolt, except when locked
- Lever outside can only be locked electronically
- Lever inside always retracts latchbolt
- Auxiliary deadlatch

72 Electrical (Fail Safe)

73 Electrical (Fail Secure)

8200 & R8200

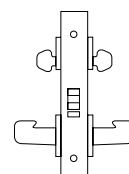

- 72 function — Power ON, locks both levers
- 73 function — Power ON, unlocks both levers
- Specify voltage: 12VDC or 24VDC (operates from 12-24VDC)
- Key on either side retracts latchbolt
- Lever from either side retracts latchbolt, except when levers are locked
- Both Levers can only be locked & unlocked electronically
- Levers can not be locked separately, only together
- Auxiliary deadlatch

Electrified Mortise Locks with Standard Monitoring Options

- Single Pole Double Throw (SPDT) type C switches
- **RX- option — Request-to-Exit or Enter Signaling Switch**
 - Two switches mounted internally in lockbody that provide independent monitoring of inside and outside lever rotation
 - Available in all functions with non rigid levers
 - Not available for the following options: 1-, 3-, 74-
 - Not available for the following trims: LS or FE
- **LX- option — Latchbolt Monitor**
 - Single switch mounted within lockbody signaling latchbolt position
 - Available for all non deadbolt functions
 - Not available with DX or 74-
- **DX- option — Deadbolt Monitor**
 - Switch mounted internally in lockbody that indicates deadbolt position
 - Not available for the following options: 3-, 74- or LX-
 - Available in all deadbolt functions

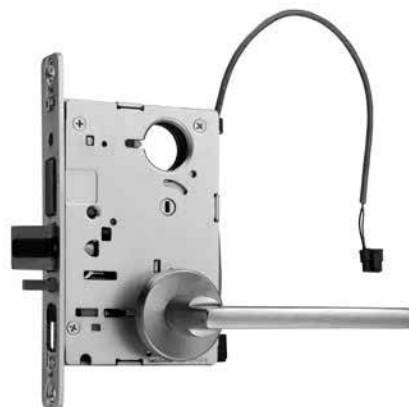

ElectroLynx®, a system of universal Molex® plug-in connectors and standardized color-coded wiring, makes installing electrified doorway components a snap!



⚠ **CAUTION:** Not recommended for use on any door used for Life Safety egress

Experience a safer
and more open world

1-800-727-5477 • www.sargentlock.com

29

Copyright © 2004-2021, SARGENT Manufacturing Company. All rights reserved. Reproduction in whole or in part without the express written permission of SARGENT Manufacturing Company is prohibited. Patent pending and/or patent www.assaabloydss.com/patents.

10/21 90115

Electrical Functions & High Security Monitoring Options

8200/R8200/7800 Series Mortise Locks

SARGENT
ASSA ABLOY

Electrified Mortise Locks with High Security Monitoring:

The high security monitoring options of our industry-leading Integrated Wiegand locks are now available in a mortise lock that can be used as a stand-alone electrified lock or in conjunction with a wall reader. Every NAC lock is shipped with door position and request to exit monitoring installed. NAC locks ordered with deadbolt are supplied with deadbolt monitoring.

Functions:

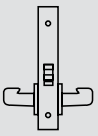
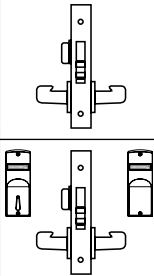
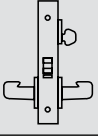
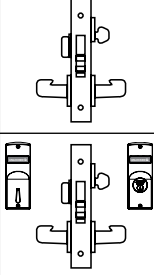
Function	Description	Illustration
NAC-82274	Fail Safe	
NAC-82275	Fail Secure	
NAC-82284	Fail Safe	
NAC-82285*	Fail Secure	
NAC-82270	Fail Safe	
NAC-82271	Fail Secure	
NAC-82280	Fail Safe	
NAC-82281*	Fail Secure	

- Fail Safe: Power off, unlocks outside trim
- Fail Secure: Power off, locks outside trim
- Key Override: Key outside retracts latch and/or deadbolt when trim is locked electronically
- Deadbolt projected and retracted by thumbturn or key

*Indicator available for NAC-82281 and NAC-82285, Fail Secure, only when used with PHR option

 Indicator options available for both sectional and escutcheon trim.

High Security Monitoring Options

• Internal End-of-Line Monitoring

Integrated directly into the mortise lock, internal end-of-line resistors monitor the line from the access control panel to the lock. Typically, resistors are installed at the panel or above the door, creating vulnerability between the resistors and the locks. Incorporating resistors within the lock eliminates any risk of undetected tampering or damage, while also reducing installation costs, simplifying specifications, and offering the assurance of a factory installed and tested product.

Select a compatible resistor configuration and add the appropriate prefix to your order string:

- **R01:** Mercury and Lenel compatible 1KΩ/2KΩ resistance supervision
- **R03:** Software House compatible 1KΩ/2KΩ resistance supervision

- **R04:** AMAG compatible 4-state supervision

• Deadbolt Privacy Function (PHR-)

- Engaging the deadbolt disables remote access control unlocking (keypad or card reader) or scheduled unlock.
- Ideal for personal privacy areas, such as nursing rooms, on-call doctors' rooms, restrooms, and shower areas
- To order, add the PHR- prefix to your order string

Note: PHR is only available on Fail Secure functions

• Integrated Door Position Switch (IDP-)

- The patented IDP option adds a magnetic door position switch in series with the internal auxiliary latch and latchbolt position switches to provide three factor monitoring.

– This offers added assurance that the door is secure, reduces the likelihood of attack, and is aesthetically pleasing because it conceals the door position switch behind the front plate and the magnet behind the strike.

- To order, add the IDP- prefix to your order string

Ordering Examples:

R01-IDP-NAC-82271-12V-LN-MD-26D-LHR
R04-PHR-IDP-NAC-82281-24V-LN-MD-26D-RHR

Electrical Requirements & Accessories

8200/R8200/7800 Series Mortise Locks

Requirements for Electrical and Data Transfer

To answer the demand for “smart” electronic access control and locking solutions that require fast, easy, and cost-effective installation, ASSA ABLOY Group brands use the ElectroLynx® standardized plug-in connectors and color-coded wiring system.

With ElectroLynx®, doorway components come pre-wired for easy hookup to the power source. The key to the system is the transfer device hinge that carries power from the frame to the locking hardware.

Features of ElectroLynx®:

- Makes it easy to bring power to the locking hardware
- Wires have connectors that snap together, like plugging a telephone into a jack

To connect an 8200 & R8200 Electrified Mortise Lock to the electronic access control system, the following items are required:

- 8200 & R8200 Electrified Mortise Lock
- ASSA ABLOY Door Group pre-wired door, or ElectroLynx® retrofit cable (order from McKINNEY)
- Electronic transfer device (ElectroLynx® electronic transfer hinge or Electrical Power Transfer with standard hinge, from McKINNEY)
- ElectroLynx® cable from the hinge to above the ceiling (order from McKINNEY)

Information regarding cable selection, hinge requirements and order strings can be found in the McKINNEY Transfer Device Solutions catalog. Consult 800-810-WIRE (9473) with questions on application specifications and requirements.

McKINNEY QC8 ElectroLynx® Hinges for 8270-8274 functions and the RX- Option is recommended.
McKINNEY QC12 ElectroLynx® Hinges for LX- or DX- Option is recommended.



12VDC & 24VDC Power Supplies:



- UL Class 2 Listed
- Four 12V models and four 24V models available
- Integral battery charging capability keeps sealed lead acid gel/cell at full charge in case of line voltage failure (737-battery sold separately)
- Fused line voltage input with one, four, or eight DC outputs (depending on model)
- Each circuit can be individually turned on and off via a slide switch; the power status of each is shown by an LED
- In the event of a DC short, the problem is confined to the zone of difficulty
- Fire alarm interface standard

SARGENT Model No.	Description
3521	12V - 1 Amp Power Supply
3541	12V - 3 Amp Power Supply
3551	12V - 4.5 Amp Power Supply
3571	12V - 6 Amp Power Supply
737	12V - 5 Amp Hour Backup Battery

SARGENT Model No.	DESCRIPTION
3520	24V - 1 Amp Power Supply
3540	24V - 2 Amp Power Supply
3550	24V - 4 Amp Power Supply
3570	24V - 6 Amp Power Supply
738	24V - 5 Amp Hour Backup Battery

Indicators

7800/8200 Series Mortise Locks



Applications

7800/8200 Series indicators can be used in a variety of applications and are most commonly used to identify occupancy or display the locked/unlocked status of a room.

- Restrooms
- Quiet rooms
- Nursing mother's rooms
- Classroom doors



Features

- Inside, outside or both sides of the door
- Sectional or escutcheon trim
- Available with 35 different functions – including thumbturn functions
- Viewing window 25% larger than competition
- Patented curved design for viewing at multiple angles
- Window located prominently above the cylinder
- Highly reflective viewing window for increased safety
- Optional directional engraving available – must specify handing
- Retrofittable for existing applications

Functions

Indicators are available with the following 7800 and 8200 Series functions. See pages 19-28 for details.

05	37	52
12	38	56
20	39	57
21	40	58
22	41	59
24	42	65
25	43	66
26	45	67
28	46	68
29	47	NAC-PHR-82281
30	50	NAC-PHR-82285
36	51	

Copyright © 2004-2021, SARGENT Manufacturing Company. All rights reserved. Reproduction in whole or in part without the express written permission of SARGENT Manufacturing Company is prohibited. Patent pending and/or patent www.assaabloydss.com/patents.

Indicators

7800/8200 Series Mortise Locks

Sectional Trim

- Surface mounted
- Torx security screws provided
- Compatible with select sectional trim rose designs: O, LN, E, TR, CR, CO, TO, E2, E3
- Compatible with all thumbturn designs
- Available with optional directional arrow engraving
- Not compatible with BHW, BHL, or BHD trims

Specify option code when ordered with lock. See page 35 for indicator codes.



Retrofit/Upgrade Kits

Retrofit/upgrade kits are available for existing applications only. Each kit includes single side indicator plate with mechanism, screw pack, plastic template and instructions.

To order retrofit/upgrade kits only, specify by model number below based upon function and mounting location. Door thickness and indicator option code must also be specified with kit.

Kits are handed and easily field reversible. All units are shipped from the factory with a default handing. Handing must be field verified and adjusted as needed per product installation instructions.

Retrofit/upgrade kits with directional engraving must include lock handing and lock function details.

See page 36 for how to order examples. **Note: Indicators for both sides of door require two kits.**

	Model #	Used with Functions	Available Option Codes	Indicator Location*
	SA190	20, 21, 22, 24, 25, 26, 28, 29, 30, 39, 40, 41, 43, 45, 46, 47, 50, 51, 52, PHR-NAC-82281	Outside Trim: V10, V20, V30, V40, V50, V60 Inside Trim: V01, V03, V04, V06	Inside and/or Outside per Function
	SA191	36, 56, 57, 58, 67		
	SA192	05, 37, 38, 42, 59		
	SA193	65, 66, 68	V10, V20, V30, V40, V50, V60	Outside
	SA194	21, 24, 25, 28, 43, 45, 47, 50, 51, 66, 68, PHR-NAC-82281, PHR-NAC-82285	V01, V03, V04, V06	Inside
	SA196	12, 56, 57, 58, 65, 67		
	SA197	12, 30, PHR-NAC-82285	Outside Trim: V10, V20, V30, V40, V50, V60 Inside Trim: V01, V03, V04, V06	Inside or Outside per Function

*When indicators are required on both sides of the door, 2 upgrade kits must be ordered, one kit for each side.

Escutcheon Trim

- Unique escutcheon (VN1) for both inside and outside of door for indicator functions
- Non-indicator functions provide with standard escutcheons as ordered, i.e. LE1, LE2, LE3, LE4, LW1, LS or WT
- Through-bolted
- Torx security screws optional
- Compatible with all thumbturn designs
- Available with optional directional arrow engraving
- Not compatible with select knob/lever designs: C, MK, MT, H001, H002, H003, H004, H005, H006, H007, H008, H009, H010, H011

Specify option code when ordered with lock. See page 35 for indicator option codes.



Trim Kits

Complete trim kits are available to retrofit/upgrade existing applications.

Trim kit includes levers and escutcheons with mechanism for both sides of door, screw pack, door marker and instructions.

To order trim kit only, specify by adding option code IS and the indicator option code (see pg. 35 for codes) to the complete order string. The IS option code will be used for all trim kits for the VN1 escutcheon with indicators. Both inside and outside will be supplied.

Option Code	Functions
IS	All functions*

*Escutcheon indicator trim kits available for all functions as listed on page 32

Note: Escutcheon applications require both sides of the door to have the unique VN1 escutcheon. Kits will be provided as a set.

How to Order Example

Option Codes	Function	Escutcheon	Lever	Door Thickness	Hand	Finish
IS-V04-	8256*	VN1	L	1-3/4"	RH	26D

* The function of the existing lock is required so the proper escutcheons can be provided.

Office & Inner Entry Lock x escutcheon trim x inside indicator - Unlocked/Locked – Red/White x trim only.

Indicators

7800/8200 Series Mortise Locks

Indicator Option Codes

7800/8200 Series indicator option codes are designed to convey wording, color and side of door desired in one simple code. To order, specify option code for complete locksets and/or retrofit/upgrade trim kits.

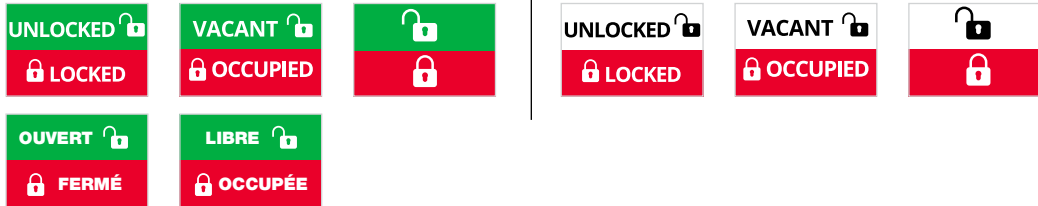

Single Indicator			
Option Code	Outside Wording	Inside Wording	Color
V10	Unlocked/Locked	No Indicator	Green/Red
V10F	Ouvert/Fermé	No Indicator	Green/Red
V20	Vacant/Occupied	No Indicator	Green/Red
V20F	Libre/Occupée	No Indicator	Green/Red
V30	Icons Only	No Indicator	Green/Red
V40	Unlocked/Locked	No Indicator	White/Red
V50	Vacant/Occupied	No Indicator	White/Red
V60	Icons Only	No Indicator	White/Red
V01	No Indicator	Unlocked/Locked	Green/Red
V01F	No Indicator	Ouvert/Fermé	Green/Red
V03	No Indicator	Icons Only	Green/Red
V04	No Indicator	Unlocked/Locked	White/Red
V06	No Indicator	Icons Only	White/Red
Double Indicator			
Option Code	Outside Wording	Inside Wording	Color
V11	Unlocked/Locked	Unlocked/Locked	Green/Red
V11F	Ouvert/Fermé	Ouvert/Fermé	Green/Red
V21	Vacant/Occupied	Unlocked/Locked	Green/Red
V21F	Libre/Occupée	Ouvert/Fermé	Green/Red
V33	Icons Only	Icons Only	Green/Red
V44	Unlocked/Locked	Unlocked/Locked	White/Red
V54	Vacant/Occupied	Unlocked/Locked	White/Red
V66	Icons Only	Icons Only	White/Red
Engraving			
Option Code	Outside	Inside	Wording
EMA	Engraving	No Engraving	"Lock" with arrow
EMB	No Engraving	Engraving	"Lock" with arrow
EMC	Engraving	Engraving	"Lock" with arrow

Copyright © 2004-2021, SARGENT Manufacturing Company. All rights reserved. Reproduction in whole or in part without the express written permission of SARGENT Manufacturing Company is prohibited. Patent pending and/or patent www.assaabloydss.com/patents.

Indicators

7800/8200 Series Mortise Locks

SARGENT
ASSA ABLOY

Engraving Options

- Laser engraving with "LOCK" and directional arrow
- Only available in the following finishes: 3, 4, 14, 15, 26, 26D
- Available with MicroShield®
- Door handing must be specified

Option Code	Description
EMA	Engraving located on outside of door
EMB	Engraving located on inside of door
EMC	Engraving located on inside and outside of door

Note: Engraving is available as an option for all functions when ordered with an indicator. Option codes must be specified with complete lock and/or retrofit (upgrade) kits/trim. EMC is not available with sectional trim upgrade kits.

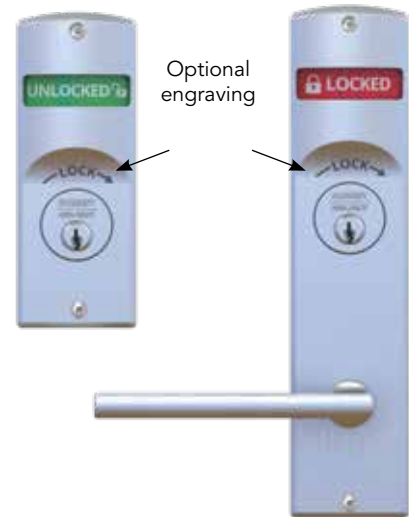

How to Order Examples

Complete with Lock

Sectional Trim

Option Code	Function	Rose	Lever	Hand	Finish
V04	8238	O	L	RH	26D

Escutcheon Trim

Option Code	Function	Escutcheon	Lever	Hand	Finish
V54 x EMB	8265	VN1	L	RH	26D

Privacy Bedroom/Bath function x escutcheon trim x double indicator - Vacant/Occupied – Red/White (Outside) Unlocked/Locked – Red/White (Inside)

Retrofit (Upgrade)/Trim Kit Only

Sectional Trim*

Option Code	Model #	Door Thickness	Finish
V04	SA190	1-3/4"	26D

Keyed function indicator for sectional trim x single indicator inside – Unlocked/Locked – Red/White

* When indicators are required on both sides of the door, 2 upgrade kits must be ordered, one kit for each side. All units are shipped from the factory with a default handing. Handing must be field verified and adjusted as needed per product installation instructions.

Escutcheon Trim

Option Codes	Function	Escutcheon	Lever	Door Thickness	Hand	Finish
IS-V04-	8256**	VN1	L	1-3/4"	RH	26D

Office & Inner Entry Lock x escutcheon trim x inside indicator - Unlocked/Locked – Red/White x trim only.

** The function of the existing lock is required so the proper escutcheons can be provided.

Copyright © 2004-2021, SARGENT Manufacturing Company. All rights reserved. Reproduction in whole or in part without the express written permission of SARGENT Manufacturing Company is prohibited. Patent pending and/or patent www.assaabloy.com/patents.

Sectional Trim Only Indicators

The following indicators are available with sectional trim only and have different features and options than the indicators found on pages 32-36. To order the following sectional indicators with locksets, specify option codes 49- or 50-.

49- Option Visual Status Indicator for Non Secure Applications

- Designed to work with Classroom security functions
- Red/White indicator plate standard
- Mounts on inside of door
- Functions and Roses available:
 - 30, 36 & 37 Functions with 7800, 8200 and R8200 locks, CR, L, LN, TR, E & O Roses
 - 26, 29, 38, 39, 40 and 41 Functions with 7800, 8200, and R8200 locks & LN Roses Only
- As retrofit, order 185C x finish

Inside Only



185C

49- Option Occupancy Indicator with Emergency Release

- Ideal for restrooms or conference rooms where easy determination of use needs to be made
- OCC/VAC indicator plate standard
- Mounts on outside of door
- Emergency coin operated release standard
- Functions and Roses available:
 - 65, 66, 68 Functions with 7800, 8200, and R8200 locks, CR, E, L, LN, O & TR Roses
- As retrofit, order 185P x finish



185P

50- Option Secured Indicator Rose

- Non-handed with lever and mounting posts field reversible
- VAC/OCC indicator plate standard
- Mounts on outside of door
- Available for the following functions: 24, 25, 26, 28, 29, 30, 36, 37, 38, 39, 40, 41, 43, 45, 50, 51, 52, 57, 58, 67 - with Rose Trim only
- Patent pending and/or patent www.assaabloydss.com/patents
- Not available with Roseless trim (R8200)
- For retrofit, order 185S x suffix x finish:



Suffix	Door Thickness
-1	1-3/8" (35mm)
-2	1-3/4" (44mm)
-3	2" (51mm)
-4	2-1/4" (57mm)

Note: For 49- and 50- Options, key will not retract latch when used with 37 and 38 functions

Thumbturn Designs

8200/R8200/7800 Series Mortise Locks

SARGENT
ASSA ABLOY

130KB Round Backplate

(Shown with Standard Turn)

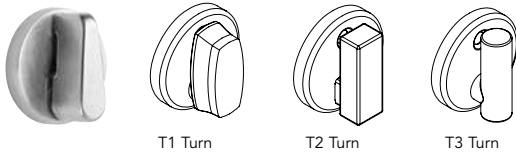

- Round backplate supplied standard with L, O, LN roses and R8200 roseless trim
- Standard turn automatically supplied with sectional trim for R8200 & 8200 locks
- Specify T1, T2 or T3 as an option for decorative turns
- 1-1/2" (38mm) round brass or stainless steel plate
- Meets ADA Requirements

130KT Traditional Backplate

(Shown with Standard Turn)

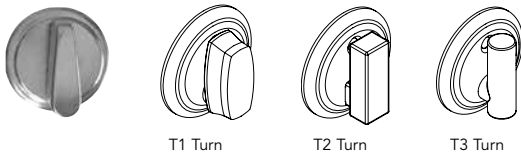

- Dual radii edge backplate supplied standard with TO and TR roses
- Standard turn automatically supplied with sectional trim for R8200 & 8200 locks
- Specify T1, T2 or T3 as an option for decorative turns
- 1-3/4" (44mm) round brass plate
- Meets ADA Requirements

130LB Large Round Backplate

(Shown with Large ADA Turn)

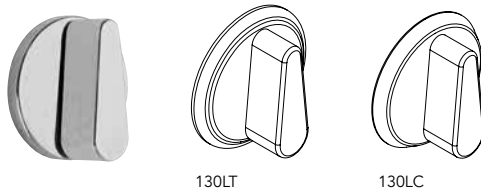

- Available with R8200 & 8200 with sectional trim
- 40% larger than standard thumbturn
- Specify LB as an option for ADA turn
- 2" (51mm) round brass, zinc, or stainless steel plate & turn
- 130LT - Traditional backplate, 130LC — Contemporary backplate
- Meets ADA Requirements

126 T-Turn

(7892 function only)



- 2-3/16" (56mm) round stainless steel backplate
- 2-3/8" (61mm) tall thumbturn
- Available in brass or bronze finishes only
- Surface mounted with three screws
- Order as "SST" trim with 7892 function

130KA Square Backplate

(Shown with Standard Turn)

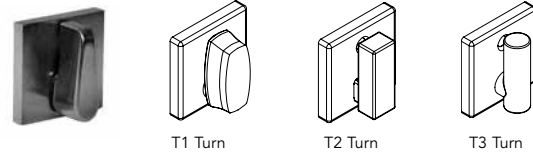

- Square backplate supplied standard with E, E2, E3 or E4 roses
- Standard turn automatically supplied with sectional trim for R8200 & 8200 locks
- Specify T1, T2 or T3 as an option for decorative turns
- 1-1/2" (38mm) round brass or stainless steel plate
- Meets ADA Requirements

130KC Contemporary Backplate

(Shown with Standard Turn)

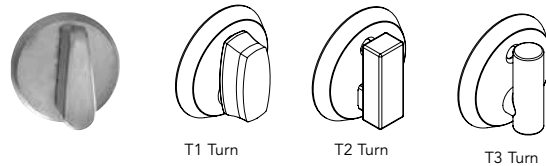

- Beveled edge backplate supplied standard with CO and CR roses
- Standard turn automatically supplied with sectional trim for R8200 & 8200 locks
- Specify T1, T2 or T3 as an option for decorative turns
- 1-3/4" (44mm) round brass or stainless steel plate
- Meets ADA Requirements

130KBHA Turn for use with 8200 Mortise BHW, ALP, BHL and BHD Trim



- 3-3/4" x 2-1/2" rectangular shape
- Stainless steel housing
- Meets ADA and OMH Requirements

130W Round Backplate

(Shown with Standard Turn)



- Used with 7800 with sectional trim
- 1-1/2" (38mm) round brass or stainless steel plate

Emergency Releases & Accessories

8200/R8200/7800 Series Mortise Locks

SARGENT
ASSA ABLOY

Emergency Releases

184KB Emergency Release (used with R8200 & 8200 with sectional trim)



- 1-1/2" (38mm) round brass, bronze or stainless steel plate
- For 65, 66 and 68 functions only

Studio Collection Emergency Release

- 184KC Emergency Release Contemporary
- 184KT Emergency Release – Traditional

184W Emergency Release (used with 7800 with sectional trim)



- 1-1/2" (38mm) round brass, bronze or stainless steel plate
- For 65, 66 and 68 functions only

184KA Emergency Release (used with E rose)



- 1-1/2" (38mm) square brass, bronze or stainless steel plate
- For 65, 66 and 68 functions only

Emergency Key 14-0057



- Carbon steel
- For 65, 66 and 68 functions only
- Must be ordered separately

184KBHA Emergency Release (used with BHW, ALP, BHL and BHD trim)



- 3-3/4" x 2-1/2" rectangular shape
- Stainless steel housing
- Meets ADA and OMH Requirements

Accessories

130KBCVR Cap



- Thumbturn plate
- Covers hole in door when thumb turn is no longer needed

82-4023 Cap



- 2" round
- Covers hole for levers and roses

Door Thickness	Part Number
1-3/8"	82-4022
1-3/4"	82-4023
2"	82-4024
2-1/4"	82-4025

Trim One Side Kit

Refer to page 51 for a complete list of kits

Cylinder Lengths (Dim X)

Cylinder No.	41	42	43	44	46	48	50	52	54	56
Dim X Length Under Cylinder Head	1-1/8" (29mm)	1-1/4" (32mm)	1-3/8" (35mm)	1-1/2" (38mm)	1-3/4" (44mm)	2" (51mm)	2-1/4" (57mm)	2-1/2" (64mm)	2-3/4" (70mm)	3" (76mm)

40 Series Type Cylinder



- Cylinder body: Solid brass
- Cap: Brass, bronze or stainless steel
- All functions take a Standard Cam Functions
- Standard Cam 13-0664
- 16 & 92 Inside Cam -105
- 50 Hotel Cam -115 supplied standard with all Hotel Function Cylinders

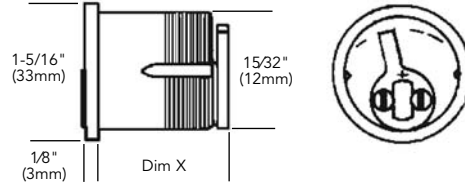

7850/8250 Function Hotel Cylinder



- When door is locked by deadbolt, only emergency key is able to unlock
- Must request emergency key separately (7268EMK x reg #)
- Supplied with Cam suffix -115 for Hotel Functions

10- Option Signature Series



- The protected system offers the building owner full control over duplication of keys. Highly pick-resistant cylinders
- 10-63- Option — Signature cylinder with Large Format Interchangeable Cores

78- Option Exposed Barrel



- Standard for use only with SARGENT Escutcheon Trims KE3, KE4, LE3, LE4
- Available 6-Pin standard or 7-Pin optional
- NOT available with 50-, 60-, 70- or other specialty or higher security options
- See function table for cam required
- Not available in 50 function
- Plug finishes: 4, 15 (similar to 26 finish)

F1-82- and 82- Option KESO



- The system offers the building owner full control over duplication of keys
- Highly pick-resistant cylinders
- Expanded levels of masterkeying
- F1-83- & 83- Option — Keso removable core
- 84- Option — Keso construction core cylinder

124 Series Mortise Cylinder Turn Lever



- Turn lever: Brass, bronze or aluminum
- Cap: Brass, bronze or stainless steel
- Must be ordered separately

11- Option XC Key System



- Key system works with existing SARGENT keyway adding increased security
- 11- XC standard cylinder
- 11-63- Large format interchangeable core
- 11-73- Small format interchangeable core

DG1, DG2, DG3 - Degree Series



- Utility patented, bump resistant and requires the use of a patented key
- All three locking mechanisms within the same system to be operated with just one key
- See Degree Key System Catalog for available options

Copyright © 2004-2021, SARGENT Manufacturing Company. All rights reserved. Reproduction in whole or in part without the express written permission of SARGENT Manufacturing Company is prohibited. Patent pending and/or patent www.assaabloydss.com/patents.

Cylinders & Rosettes

8200/R8200/7800 Series Mortise Locks

SARGENT
ASSA ABLOY

51- Option Old Style Removable Core



- Available for **existing systems only** Permanent Removable Cores
- Control key used to remove core, must request control key separately

60- or 70- Option Plastic Construction Core



- For doors that do not require key locking during the construction period
- Operate with coin or flat screw driver
- For use with LFIC (removable) (60-Option) or SFIC (70-Option) core

63- Option Large Format Interchangeable (Removable) Core



- Allows immediate removal of the core. Virtually unlimited key changes
- Available 10-63-, 11-60-, 11-63- & 11-64-
- For disposable core, see 60- Option
- 64- Option- LFIC 6-Pin construction core
- Control key used to remove core, must request control key separately

7300B Interchangeable Core



- Small Format Interchangeable Core (SFIC)
- SARGENT Interchangeable Core cylinders and MasterKey Systems are available for increased security through quick change of keying. It is unnecessary to remove a cylinder
- SARGENT 7300B Interchangeable Cores are available in SARGENT 4A and 4B keyways, as well as the following standard competitor keyways: A, B, C, D, E, F, G, H, J, K, L, M
- For disposable core, see 70- Option
- 65-73 Option — 6-Pin SFIC uncombined
- 65-73-7P Option — 7-Pin SFIC - uncombined
- 70- Option — Disposable SFIC
- 72- Option — Construction SFIC
- 11-72- Construction core provided for use with 11-7300 cylinder housing 11-70- temporary plastic core prepared to accept 11-7300 core
- 73- Option — 6-Pin SFIC, SARGENT 4A, 4B keyways
- 73-7P Option — 7-Pin SFIC, SARGENT 4A, 4B keyways
- Control key used to remove core (ordered separately)

1SB Cylinder Collar



- Standard for 7800 BHD, 8200 BHL & BHW mortise locks
- Stainless steel
- 1-29/32" diameter
- Available in 4 sizes
- Projection from door:

1SB-1	5/16" (8mm)
1SB-2	7/16" (11mm)
1SB-3	9/16" (14mm)
1SB-4	11/16" (16mm)
- Finishes: 32, 32D

21- Option Lost Ball Construction System

- The SARGENT construction keying system protects the building owner by providing temporary masterkeying during the construction period

1KB Rosette with 8200 & R8200 sectional trim



- Used with mortise cylinders and No. 90 blocking rings when cylinders project from door
- Furnished standard with L, O, LN, CO, CR, TO and TR roses
- Brass, bronze or stainless steel
- 1-1/2" (38mm) diameter, includes compression spring
- Finishes: 3, 4, 10, 10B, 10BE, 10BL, 20D, 26, 26D, 32, 32D, BSP, WSP
- Projection from door:

1KB-1	5/16" (8mm) — Standard
1KB-2	7/16" (11mm)
1KB-3	9/16" (14mm)
1KB-4	11/16" (16mm)

1KA Rosette with 8200 sectional trim



- Used with mortise cylinders
- Furnished standard with the E, E2, E3 and E4 roses
- Brass, bronze or stainless steel
- 1-1/2" (38mm) Square, includes compression spring
- Projection from door:

1KA-1	5/16" (8mm) — Standard
1KA-2	7/16" (11mm)
1KA-3	9/16" (14mm)
1KA-4	11/16" (16mm)
- Finishes: 3, 4, 10, 10B, 10BE, 10BL, 20D, 26, 26D, 32, 32D, BSP, WSP

No. 97 Rosette



- Standard for cylinders ordered separately from hardware
- Standard for 7800 knob mortise & 4870 deadbolt
- Brass, bronze or stainless steel
- 1-11/16" diameter (43mm), 9/32" (7mm) projection, includes compression spring
- Finishes: 3, 4, 10, 10B, 10BE, 10BL, 20D, 32, 32D, BSP, WSP

No. 90 Blocking Ring



- Used with 1KB rosettes as spacer when mortise cylinder projects from face of door
- Brass, bronze or stainless steel
- Finishes: 3, 4, 10, 10B, 10BE, 10BL, 20D, 26, 26D, 32, 32D, BSP, WSP

1KB-5 Cylinder Retaining Cap



- Required for double cylinder functions on KS and LS Escutcheon *only*
- Steel or stainless steel
- 1-15/32" (37mm) diameter
- 9/16" (14mm) projection
- Finishes: 3, 4, 9, 10, 10B, 10BE, 10BL, 20D, 26, 26D, 32, 32D, BSP, WSP

Experience a safer
and more open world

1-800-727-5477 • www.sargentlock.com

41

Copyright © 2004-2021, SARGENT Manufacturing Company. All rights reserved. Reproduction in whole or in part without the express written permission of SARGENT Manufacturing Company is prohibited. Patent pending and/or patent www.assaabloydss.com/patents.

90115 10/21

Rosette Requirements & Cams

8200/R8200/7800 Series Mortise Locks

SARGENT
ASSA ABLOY

Single Cylinder

Double Cylinder

Sectional Trim (CO, CR, L, LN, O, PT, SL, SN, TO, TR)

Cylinder Size	Door Thickness			
	1-3/8"	1-3/4"	2"	2-1/4"
41	1KB-2	1KB-1	1KB-1	N/A
42	1KB-3	1KB-2	1KB-2	1KB-1
43	1KB-4	1KB-3	1KB-3	1KB-3

Cylinder Size	Door Thickness			
	1-3/8"	1-3/4"	2"	2-1/4"
41	1KB-3	1KB-2	1KB-1	N/A
42	1KB-4	1KB-3	1KB-2	1KB-1
43	97-0352	1KB-4	1KB-3	1KB-2

Sectional Trim (E, E2, E3, E4)

Cylinder Size	Door Thickness			
	1-3/8"	1-3/4"	2"	2-1/4"
41	1KA-2	1KA-1	1KA-1	N/A
42	1KA-3	1KA-2	1KA-2	1KA-1
43	1KA-4	1KA-3	1KA-3	1KA-3

Cylinder Size	Door Thickness			
	1-3/8"	1-3/4"	2"	2-1/4"
41	1KA-3	1KA-2	1KA-1	N/A
42	1KA-4	1KA-3	1KA-2	1KA-1
43		1KA-4	1KA-3	1KA-2

Escutcheon Trim (CE, KE1, KE2, KW1, LE1, LE2, LW1, TE)

Cylinder Size	Door Thickness			
	1-3/8"	1-3/4"	2"	2-1/4"
41	1KB-1	Cylinder Only	Cylinder Only	Cylinder Only
42	1KB-2	1KB-1	Cylinder Only	Cylinder Only
43	1KB-3	1KB-1	1KB-1	Cylinder Only

Cylinder Size	Door Thickness			
	1-3/8"	1-3/4"	2"	2-1/4"
41	1KB-2	90 1/8	Cylinder Only	Cylinder Only
42	1KB-3	1KB-2	1KB-1	Cylinder Only
43	1KB-4	1KB-3	1KB-2	90 1/8

Escutcheon Trim (WT)

Cylinder Size	Door Thickness			
	1-3/8"	1-3/4"	2"	2-1/4"
41	97	Cylinder Only	Cylinder Only	Cylinder Only
42	1SB-2	97	Cylinder Only	Cylinder Only
43	1SB-3	97	97	Cylinder Only

Cylinder Size	Door Thickness			
	1-3/8"	1-3/4"	2"	2-1/4"
41	1SB-2	97	Cylinder Only	Cylinder Only
42	1SB-3	1SB-2	97	Cylinder Only
43	1SB-4	1SB-2	1SB-2	97

Specialty Hardware (BHW, BHL, BHD, ALP)

Cylinder Size	Door Thickness			
	1-3/8"	1-3/4"	2"	2-1/4"
41	1SB-2	1SB-1	1SB-1	N/A
42	1SB-3	1SB-2	1SB-2	1SB-1
43	1SB-4	1SB-3	1SB-3	1SB-3

Cylinder Size	Door Thickness			
	1-3/8"	1-3/4"	2"	2-1/4"
41	1SB-3	1SB-2	1SB-1	N/A
42	1SB-4	1SB-3	1SB-2	1SB-1
43	1SB-4	1SB-4	1SB-3	1SB-2

Sectional and Escutcheon Trim with V Series Indicators

Cylinder Size	Door Thickness			
	1-3/8"	1-3/4"	2"	2-1/4"
41	Cylinder Only	Cylinder Only	N/A	N/A
42	1KB-1	Cylinder Only	Cylinder Only	N/A
43	1KB-2	1KB-1	Cylinder Only	Cylinder Only

Cylinder Size	Door Thickness			
	1-3/8"	1-3/4"	2"	2-1/4"
41	1KB-1	Cylinder Only	N/A	N/A
42	1KB-1	1KB-1	Cylinder Only	N/A
43	1KB-2	1KB-1	1KB-1	Cylinder Only

Cylinder Cams For Mortise Locks

SARGENT Conventional Cylinders

- Standard

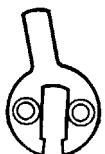

Std Cam
(13-0664)
for all functions except for 50 and the Inside cam for 16 & 92 function locks



-105 Cam
(13-0665)
16 & 92 Function Inside Cylinder Cam

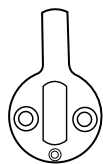

-115 Cam
(13-2045)
50 Function Hotel Cam, supplied with 50 function cylinders



Std 6300 Cam
for all functions except for 50 and the Inside cam for 16 & 92 function locks



-105 Cam
for 6300 Series 16 & 92 function I/S Cylinder



-115 Cam
for 6300 Series 50 (Hotel) function, supplied with 50 function cylinders

SARGENT Large Format Interchangeable Core Cylinders

- 6300 Cams are factory installed and are not removable
- 6300 Cams are not sold separately
- Specify required Cam as a suffix: 63-44-105 cam
- For Standard Cam: no suffix is required

See Cylinder catalogs for additional information

Experience a safer and more open world

Strikes & Fronts

8200/R8200/7800 Series Mortise Locks

- Curved lip strikes: Brass, bronze or stainless steel
- 877 Open back strike: Brass plated
- To order strikes separately, specify strike part number and finish. Will be furnished with machine screws

- Order strike box 77-1141 separately
- All locks are packed standard with a universal non-handed curved lip ANSI 4-7/8" (124mm) strike
- Specify part number when ordering with complete lock

- Open back strike not available for deadbolt functions

Curved Lip Strike

Door Thickness	Part No.	Lip Length
1-3/8" – 1-1/2" (35mm - 38mm)	82-0109	1-1/8" (29mm)
1-5/8" – 1-3/4" (41mm – 44mm)	82-0110 Standard	1-1/4" (32mm)
1-7/8" – 2" (48mm – 51mm)	82-0111	1-3/8" (35mm)
2-1/8" – 2-1/2" (54mm – 64mm)	82-0112	1-5/8" (41mm)
2-5/8" – 3" (67mm – 76mm)	82-0113	1-7/8" (48mm)
3-1/8" – 3-1/2" (79mm – 89mm)	82-0114	2-1/8" (54mm)
3-3/8" – 4" (86mm – 101mm)	82-0115	2-3/8" (61mm)
4-1/8" – 4-1/2" (105mm – 114mm)	82-0116	2-5/8" (67mm)
4-5/8" – 5" (117mm – 127mm)	82-0117	2-7/8" (73mm)

Strike screw: 01-1019 x finish

Curved Lip Strike (Standard)

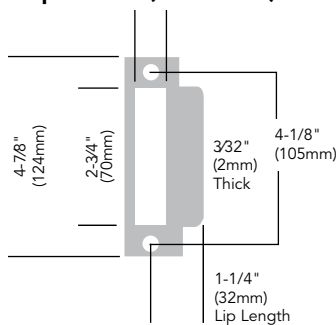

78-0034 Deadbolt Strike

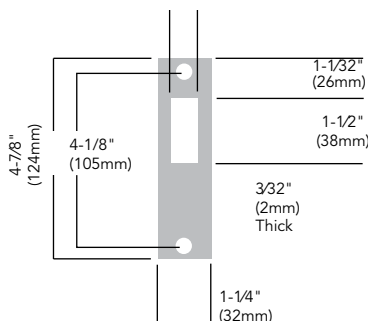

- Provided standard with deadlock functions 03, 20, 21, 22, 23, 28, 29, 30

877 Open Back Strike

- Strike handed by **active leaf**

Door Thickness	Part No. RHRB	Part No. LHRB
1-3/4" (44mm)	82-0332	82-0333
2" (51mm)	82-0334	82-0335
2-1/4" (57mm)	82-0336	82-0337
2-1/2" (64mm)	82-0338	82-0339
2-3/4" (70mm)	82-0340	82-0341
3" (76mm)	82-0342	82-0343

877 Open Back Strike

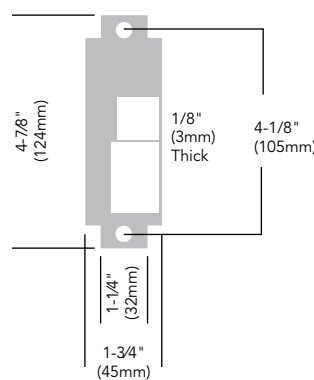

77-1141 Wrought Box Strike

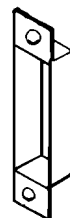

- For both curved and flat lip strikes
- Optional: Specify WBS- when ordering with lock
- If ordering separately, use part # 77-1141

Outside Front Plate

(for 1- options fronts, consult factory)

Standard 1-1/4" (32mm)	Functions
82-0080	12, 15, 65
82-0081	04, 05, 06, 13, 16, 17, 31, 36, 37, 38, 56, 57, 58, 59, 67
82-0082	03, 20, 21, 22, 23, 28, 29, 30
82-0083	24, 25, 26, 27, 35, 39, 49, 66, 68
82-0084	40, 41, 50, 51, 52
82-0086	45, 46, 47, 48
82-0087	43
82-0088	89, 90, 91, 92
82-0578	70, 71, 72, 73, 78, 79
82-0549	76, 77
82-0627	95, 96, 97
82-0085	55

Outside front screws: 01-1028 x finish

Outside Front Plate

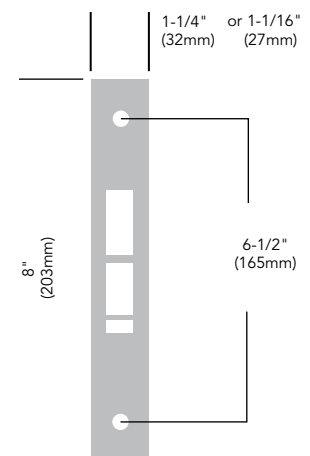

No. 677 Rabbeted Door Kits

677 Kit adapts 7800/8200 locks for rabbeted doors consists of rabbeted strip and strike. standard for 1-3/4" to 2" doors.

Specify 2-677 for 2-1/4" thick doors. Hardware finished.

Experience a safer and more open world

1-800-727-5477 • www.sargentlock.com

ADA and Handicap Warning

Lever Return to Door



- Lever designs H002, H005, H006, H016, J, L, MX, MW, MZ, ND, NF, NJ, NS, NU, P
- Lever returns within 1/2" (13mm) of door face or less
- Meets ADA Compliance for national codes

Tactile Handicapped Warning



- Abrasive Coating: Options 85-, 86- & 87-
 - Complete lever abrasive coated
- Milled 1/16" Grooves: Options 75-, 76- & 77-
 - B, E, J, L, P and W Levers — Grooves on backside surface of lever
 - F Lever — Grooves on top and bottom surface of lever

Standard Thumbturn

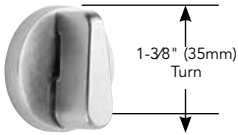

- Meets ADA Compliance for national codes
- Order as: 130KB, 130KC, 130KT, 130W or 130KA x finish

See page 38 for design

Tactile Handicapped Warning



- Knurled B & C Knobs available ; options 75-, 76-, & 77-
- Knobs are NOT ADA compliant

LB - Thumbturn

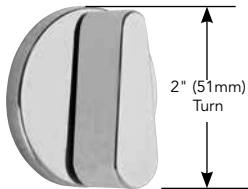

- Meets the tougher local ADA requirements
- 40% larger than standard thumb turn
- Order as: 130LB, 130LC or 130 LT x finish

See page 38 for design

Keys



- Large key bows are available in Sargent C family of keyways
- Standard key bows can have attachments added to increase the grip area
- Keys are NOT ADA compliant

Mechanical Options

8200/R8200/7800 Series Mortise Locks

Mechanical Options:

Available mechanical options by lock type

Categories	How to Specify	Detailed Description	8200	R8200	7800
1-3/8" Door	1-	1-1/16" (27mm) wide front for 1-3/8" (35mm) doors (not available with RX-Option) (1- for 93 + 94 function is a special order)	X	—	X
Add Strength	3-	Stainless steel hubs with in the mortise lock	X	—	—
Strike Option	23-	4-7/8" (124mm) ANSI flat lip strike	X	X	X
	OBS-	Open back strike	X	X	X
	WBS-	Wrought box strike	X	X	X
Thick Doors	31-	For doors 1-7/8" (48mm) to 2-1/4" (57mm) thick — see cylinder options for limitations on door thickness. When ordering the following information is required: Location of lock within the door, door thickness -IF paneled -must specify panel thickness & panel location (inside or outside of the door) For doors thicker than 2-1/4" — consult factory.	X	X	X
Security Fasteners	36-	6 Lobe head security screws (Torx® type)	X	—	X
	37-	Spanner head security screw (not available with Studio levers)	X	—	X
Visual Indicators	49-	Visual Status Indicator or Occupancy indicator with emergency release (not available with escutcheon trim)	X	X	X
	50-	Secured indicator rose (available with rose trim only)	X	—	X
	V10	Single Indicator Outside - Unlocked/Locked - Green/Red	X	—	X
	V20	Single Indicator Outside - Vacant/Occupied - Green/Red	X	—	X
	V30	Single Indicator Outside - Icons Only - Green/Red	X	—	X
	V40	Single Indicator Outside - Unlocked/Locked - White/Red	X	—	X
	V50	Single Indicator Outside - Vacant/Occupied - White/Red	X	—	X
	V60	Single Indicator Outside - Icons Only - White/Red	X	—	X
	V01	Single Indicator Inside - Unlocked/Locked - Green/Red	X	—	X
	V03	Single Indicator Inside - Icons Only - Green/Red	X	—	X
	V04	Single Indicator Inside - Unlocked/Locked - White/Red	X	—	X
	V06	Single Indicator Inside - Icons Only - White/Red	X	—	X
	V11	Double Indicator - Unlocked/Locked - Green/Red (Outside) Unlocked/Locked - Green/Red (Inside)	X	—	X
	V21	Double Indicator - Vacant/Occupied - Green/Red (Outside) Unlocked/Locked - Green/Red (Inside)	X	—	X
	V33	Double Indicator - Icons Only - Green/Red (Outside) Icons Only - Green/Red (Inside)	X	—	X
	V44	Double Indicator - Unlocked/Locked - White/Red (Outside) Unlocked/Locked - White/Red (Inside)	X	—	X
	V54	Double Indicator - Vacant/Occupied - White/Red (Outside) Unlocked/Locked - White/Red (Inside)	X	—	X
	V66	Double Indicator - Icons Only - White/Red (Outside) Icons Only - White/Red (Inside)	X	—	X
	EMA	Outside Engraving with "Lock" and Directional Arrow	X	—	X
	EMB	Inside Engraving with "Lock" and Directional Arrow	X	—	X
EMC	Engraving Both Sides with "Lock" and Directional Arrow	X	—	X	
Visual Indicators - French	V10F	Single Indicator Outside - Ouvert/Fermé - Green/Red	X	—	X
	V20F	Single Indicator Outside - Libre/Occupée - Green/Red	X	—	X
	V01F	Single Indicator Inside - Ouvert/Fermé - Green/Red	X	—	X
	V11F	Double Indicator - Ouvert/Fermé - Green/Red (outside) Ouvert/Fermé - Green/Red (inside)	X	—	X
	V21F	Double Indicator - Ouvert/Fermé - Green/Red (outside) Libre/Occupée - Green/Red (inside)	X	—	X

* Available on 15, 26D, and 32D Finishes only

** Not available in combination

Copyright © 2004-2021, SARGENT Manufacturing Company. All rights reserved. Reproduction in whole or in part without the express written permission of SARGENT Manufacturing Company is prohibited. Patent pending and/or patent www.assaabloydss.com/patents.

Mechanical Options

8200/R8200/7800 Series Mortise Locks

SARGENT
ASSA ABLOY

Categories	How to Specify	Detailed Description	8200	R8200	7800
Electrical Options	DX-	Deadbolt monitoring — Monitor deadbolt position (not available with LX-)	X	X	X
	LX-	Latchbolt monitor — Monitors latchbolt position (not available with deadbolt functions)	X	X	X
	RX-**	Request to Exit — Monitors each lever independently (not available with LB-option)	X	X	X
	TL-	SARGuide illuminated inside WT trim with the word EXIT illuminated (4-1/2" pocket depth required)	X	—	—
Lever/Knob Combination	68-	8200 Lock furnished w/lever handle outside x knob inside (not available with the AV-Option or FE Trim)	X	—	—
	69-	8200 Lock furnished w/lever handle inside x knob outside (not available with the AV-Option or FE Trim)	X	—	—
Lead Lining	74. ²	Lead lining or wrapping available with sectional trim only (not available with DX-or LX-Options)	X	—	X
Tactile Warnings	75-	Tactile Warning — Milled levers or knurled knobs. Inside trim only (not available with Studio & Coastal levers, the A lever & K, N & D knobs)	X	—	X
	76-	Tactile Warning — Milled levers or knurled knobs. Outside trim only (not available with Studio & Coastal levers, the A lever & K, N & D knobs)	X	—	X
	77-	Tactile Warning — Milled levers or knurled knobs. Inside & outside trim (not available with Studio & Coastal levers, the A lever & K, N & D knobs)	X	—	X
	85. ³	Tactile Warning — Abrasive coating inside trim only (not available with D knobs)	X	X	X
	86. ³	Tactile Warning — Abrasive coating outside trim only (not available with D knobs)	X	X	X
	87. ³	Tactile Warning — Abrasive coating inside & outside trim (not available with D knobs)	X	X	X
Anti-Vandal Trim	AV-	Anti-Vandal pull trim (not available with LS & FE trim and Options 1-, 31-, 49-, 50-, 68-, 69-, 76-, 77-, 86-, 87-, DX-or SG-)	X	—	X
Finish Protection	CPC-	Clear Powder Coat (available for 32 & 32D finishes)	X	X	X
	SG- ¹	MicroShield® antimicrobial clear powder coat	X	X	X
Thumbturns (See page 38)	LB-	ADA Extra large thumbturn; backplate matches rose design chosen	X	X	X
	T1-	Decorative thumbturn; backplate matches rose design chosen	X	X	—
	T2-	Decorative square thumbturn; backplate matches rose design chosen	X	X	—
	T3-	Decorative cylinder thumbturn; backplate matches rose design chosen	X	X	—

- 1 Available on 15, 26D, and 32D Finishes only
- 2 Not available in combination
- 3 Entire lever surface provided with abrasive coating

Copyright © 2004-2021, SARGENT Manufacturing Company. All rights reserved. Reproduction in whole or in part without the express written permission of SARGENT Manufacturing Company is prohibited. Patent pending and/or patent www.assaabloydss.com/patents.

Cylinder Options

8200/R8200/7800 Series Mortise Locks

SARGENT
ASSA ABLOY

Cylinder Options:

Categories	How to Specify	Detailed Description	Cylinder Sizes Available
Conventional Cylinder		SARGENT Conventional Cylinders supplied standard	41-44,46,48,50,52,54,56
Degree Key System	DG1-	SARGENT Degree Key System Level 1 (bump resistant with patented keys)	41-44, 46
	DG1-21-*	Degree Level 1 Construction Master Keying	41-44, 46
	DG1-60-	Degree Level 1 Removable Disposable Construction Core	41-44, 46
	DG1-63-	Degree Level 1 Removable Core	41-44, 46
	DG1-64-	Degree Level 1 Removable Construction Keyed LFIC	41-44, 46
	DG1-65-*	Degree Level 1 Unassembled/Uncombined Core	41-44, 46
	DG1-78-*	Degree Level 1 Exposed Plug (for use with LE3/LE4 escutcheons only)	41-43
	DG2-+*	SARGENT Degree Key System Level 2 (geographically exclusive; bump and pick resistant)	41-44, 46
	DG2-21-*	Degree Level 2 Construction Master Keying	41-44, 46
	DG2-60-*	Degree Level 2 Removable Disposable Construction Core	41-44, 46
	DG2-63-*	Degree Level 2 Removable Core	41-44, 46
	DG2-64-*	Degree Level 2 Removable Construction Keyed LFIC	41-44, 46
	DG2-65-*	Degree Level 2 Unassembled/Uncombined Core	41-44, 46
	DG3-+*	SARGENT Degree Key System Level 3 (geographically exclusive; UL437 certified; bump and pick resistant)	41-44, 46
	DG3-21-*	Degree Level 3 Construction Master Keying	41-44, 46
	DG3-60-*	Degree Level 3 Removable Disposable Construction Core	41-44, 46
DG3-63-*	Degree Level 3 Removable Core	41-44, 46	
DG3-64-*	Degree Level 3 Removable Construction Keyed LFIC	41-44, 46	
Signature Key System	10-*	SARGENT Signature Key System (not available with other key systems)	41-44,46,48,50,52,54,56
	10-21-*	SARGENT Signature Construction Key System (Lost Ball)	41-44,46,48,50,52,54,56
Signature Large Format Interchangeable Core (Removable Core)	10-63-*	SARGENT Signature LFIC (removable) Core Cylinder	42, 43, 44 & 46
XC- Key System	11-*	XC Key System (not available with other key systems, unless specified)	41-44,46,48,50,52,54,56
	11-21-*	XC- Construction Key System (Lost Ball)	41-44,46,48,50,52,54,56
XC- Large Format Interchangeable Core (Removable Core)	11-60-*	Hardware to accept XC- Permanent LFIC (removable core), disposable plastic core provided	42, 43, 44 & 46
	11-63-*	Hardware provided with XC- LFIC (removable core) cylinder (Includes masterkeying, grand masterkeying)	42, 43, 44 & 46
	11-64-*	Hardware provided with keyed construction core to accept XC- LFIC (removable) permanent core ordered separately	42, 43, 44 & 46
XC- Small Format Interchangeable Cores	11-70-7P-*	Hardware to accept XC- SFIC (7-Pin) XC- permanent cores, disposable plastic core provided	43 & 46
	11-72-7P-*	Hardware to accept XC- SFIC (7-Pin keyed construction core provided) cylinder permanent core ordered separately	43 & 46
	11-73-7P-*	Hardware provided with XC- Small format 7-Pin interchangeable core (Includes masterkeying, grand masterkeying)	43 & 46
	11-65-73-7P-*	Hardware provided to accept XC- Uncombined 7-Pin SFIC (permanent) core (packed loose)	43 & 46
Construction Key System	21-*	SARGENT Lost Ball Construction keying for conventional, XC and Signature Series (N/A with 63- or 73-)	—
	22-*	SARGENT Construction Split Key System for conventional cylinders (existing systems only) (N/A with 10-, 11-, 63- or 73-)	—
Old Style Removable Core	51-*	Removable core cylinder (Old style) provided (existing systems only)	142,143,144,146
	52-*	Removable construction core (Old style) permanent core ordered separately (existing systems only)	142,143,144,146

* Options not available with 50 function lockout cylinder

+ Not available with R8200 Series

Note: Interchangeable core and removable core cylinders do not meet Security Grade 1 requirements

Experience a safer
and more open world

1-800-727-5477 • www.sargentlock.com

47

Copyright © 2004-2021, SARGENT Manufacturing Company. All rights reserved. Reproduction in whole or in part without the express written permission of SARGENT Manufacturing Company is prohibited. Patent pending and/or patent www.assaabloydss.com/patents.

90115 10/21

Cylinder Options

8200/R8200/7800 Series Mortise Locks

SARGENT
ASSA ABLOY

Cylinder Options:

Categories	How to Specify	Detailed Description	Cylinder Sizes Available
Large Format Interchangeable Core	60-	Hardware to accept SARGENT permanent LFIC (removable core), disposable plastic core provided (permanent cores ordered separately)	42, 43, 44 & 46
	63-	Hardware provided with LFIC (removable core) cylinder - (Includes masterkeying, grand masterkeying)	42, 43, 44 & 46
	64-	Hardware provided with Keyed construction core to accept LFIC (removable) permanent core (ordered separately)	42, 43, 44 & 46
Small Format Interchangeable Cores	70-*	Hardware to accept 6- or 7-Pin SFIC permanent cores, disposable plastic core provided	43 & 46
	72-*	Hardware to accept 6- or 7-Pin SFIC (keyed construction core provided) cylinder (permanent core ordered separately)	43 & 46
	73-*	Hardware provided with 6-Pin SFIC (Includes masterkeying, grand masterkeying)	43 & 46
	65-73-*	Hardware provided to accept uncombined 6-Pin SFIC (permanent) core — (packed loose for field keying)	43 & 46
	65-73-7P-*	Hardware provided to accept uncombined 7-Pin SFIC (permanent) core — (packed loose for field keying)	43 & 46
	73-7P-*	Hardware provided with Small Format 7-Pin interchangeable core (Includes masterkeying, grand masterkeying)	43 & 46
Keso & Keso F1	81-*	Hardware provided with housings to accept Keso (83) & Keso F1 (F1-83-) removable cores (permanent cores ordered separately)	172-174,176
	82-	Hardware provided with SARGENT Keso security cylinder	71-74,76
	F1-82-	Hardware provided with SARGENT Keso F1 security cylinder (patented)	71-74,76
	83-*	Hardware provided with SARGENT Keso security removable core cylinder	172-174,176
	F1-83-*	Hardware provided with SARGENT Keso F1 security removable core cylinder (patented)	172-174,176
	84-*	Hardware provided with SARGENT Keso construction cores (permanent cores ordered separately)	172-174,176
Additional Security	BR-	Bump resistant cylinder (available with conventional & conventional XC cylinders only)	—
Less Cylinder	LC-	Less cylinder – SARGENT supplies standard blocking rings for 1-1/8" cylinders (for longer cylinders order collars/rings separately)	—
Schlage Keyways	SC-^*	Schlage C keyway cylinder, 0 bitted	#41 Only
	SE-^*	Schlage E keyway cylinder, 0 bitted	#41 Only

^ Options not available with Freewheeling Trim

* Options not available with 50 function lockout cylinder

Note: When using Interchangeable Core Cylinders, the ANSI/BHMA Cylinder Grade determines the grade of the lock, even if the lock is certified ANSI/BHMA Grade 1 with a standard cylinder

Cylinder Length	SARGENT Cylinder Sizes	Keso Cylinder Sizes	Keso R/C Cylinder Sizes
1-1/8"	#41	#71	N/A
1-1/4"	#42	#72	#172
1-3/8"	#43	#73	#173
1-1/2"	#44	#74	#174
1-3/4"	#46	#76	#176
2"	#48	N/A	N/A
2-1/4"	#50	N/A	N/A
2-1/2"	#52	N/A	N/A
2-3/4"	#54	N/A	N/A
3"	#56	N/A	N/A

Copyright © 2004-2021, SARGENT Manufacturing Company. All rights reserved. Reproduction in whole or in part without the express written permission of SARGENT Manufacturing Company is prohibited. Patent pending and/or patent www.assaabloydss.com/patents.

90115 10/21

How To Order, Finishes, Packaging & Security Screw Chart

8200 Series Mortise Locks

How to Order 8200, R8200 & 7800 Series Mortise Locks

10- Options*	82 Series	71 Function	12VDC Voltage	TR Roses/ Escutcheons	MJ Trim	15 Finish	RHR Hand
For all available options see Pages 45-48	82 R82 78 Mortise Lock	Pages 19-28 for Details	12VDC 24VDC	Pages 10-13 (With R8200, specify "R" for roseless design)	Levers — Pages 8-12 FW Trim — Page 14, Push/Pull Trim — Page 18, Knobs — Page 15	Page 49	RHR
			Must be specified for Functions 70, 71, 72 & 73				RH
							LHR
							LH

* Multiple options can be selected

Finishes

Standard Levers & Knobs	BHW Trim	BHL Trim	BHD Trim	Studio Collection Lever Trim	8200 Coastal Series™ Trim and 8200 Freewheeling Trim	7800 Push/Pull Trim	Description	ANSI/BHMA
03				03	03	03	Polished brass, clear coated	605
04				04	04	04	Satin brass, clear coated	606
09				09	09	09	Polished bronze, clear coated	611
10				10	10	10	Satin bronze, clear coated	612
10B				10B	10B	10B	Oxidized bronze, oil rubbed	613
10BE				10BE	10BE		Dark oxidized satin bronze, equivalent	(613E)
10BL				10BL	10BL		Oxidized satin, bronze, clear coated	614
14				14	14		Polished nickel, clear coated	618
15 *				15 *	15 *		Satin nickel, clear coated	619
20D				20D	20D		Statuary dark bronze, clear coated	624
26				26	26		Polished chrome	625
26D *				26D *	26D *		Satin chrome	626
32	32	32	32	32		32	Polished stainless steel	629
32D *	32D *	32D *	32D *	32D *		32D *	Satin stainless steel	630
BSP				BSP	BSP		Black suede powder coat	—
WSP				WSP	WSP		White suede powder coat	—

* MicroShield® — optional designate SG- option (Available on 15, 26D, and 32D Finishes only)
Split Finishes — specify outside finish first, then inside finish example: US26D (outside) / US04 (inside)

6 Lobe & Spanner Bit packs

Part Number	Descriptions
82-3855	6 Lobe Bit Pack 6 bits
82-3856	(sizes- T8, T9, T10, T15, T20, T25, T27) 9/32" Driver Spanner Bit Pack 5 bits (sizes- 6, 8, 10, 12, 14) 1/4" Driver

Packaging

8205 x LNL	approx. 6.1 lbs. (2.7kg)/box	6 boxes/case
8205 x WTL	approx. 7.2 lbs. (3.1kg)/box	6 boxes/case

Door Handing

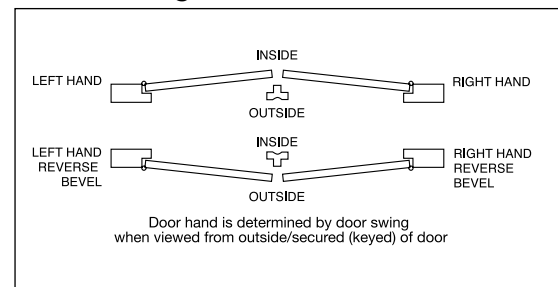

* Multiple options available
Wrought Box Strike optional — must order with lockset as WBS- option

How to Order Gramercy Series Levers

8200/R8200/7800 Series Mortise Locks

SARGENT
ASSA ABLOY

Gramercy Series Levers

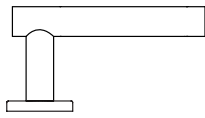

REM, RGM

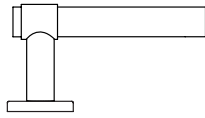

RCM

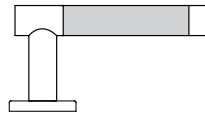

RAG, RAL, RAM, RAS

Gramercy Finish Codes

ANSI/BHMA Finish	SARGENT Finish	Gramercy Code*	Description
630	32D	30	Satin Stainless Steel
629	32	29	Bright Stainless Steel
613E	10BE	3E	Dark Oxidized Satin Bronze, Equivalent
N/A	BSP	BS	Black Suede Powder Coat
N/A	WSP	WS	White Suede Powder Coat
N/A	N/A	BK	Black (Santoprene™ or leather insert)
N/A	N/A	BN	Brown (leather insert)

*Code used to specify Gramercy Series finishes only. Use available finishes list to specify desired finish when ordering.

Gramercy Lever Descriptions & Available Finishes

Lever Designation	Lever Description	Available Finishes (AS ORDERED)
RAG	Grooved Insert	3030, 2929, 2930, 3029, 3E3E, BSBS or WSWS
RAL	Leather Insert	30BK30, 30BN30, 29BK30, 29BN30, 3EBK3E, BSBKBS, WSBKWS, 3EBN3E, BSBNBS or WSBNWS
RAM	Satin Metal Insert	2930 only (SEE NOTATION)
RAS	Santoprene Insert	30BK30, 29BK29, 3EBK3E, BSBKBS or WSBKWS
RCM	Raised Band	2930, 2929, 3030, 3029, 3E3E, BSBS or WSWS
REM	Plain	2930, 2929, 3030, 3029, 3E3E, BSBS or WSWS
RGM	Two Grooves	2929, 3030, 3E3E, BSBS or WSWS

Notes for Two-tone finishes:

- 2930 Finish: grip of lever is 32D, balance of lever is 32. Rose/escutcheon and lock finish will be 32
- 3029 Finish: grip of lever is 32, balance of lever is 32D. Rose/escutcheon and lock finish will be 32D

To order Gramercy Series levers with SARGENT products, see the examples below. When specifying finish, use the last two digits of the ANSI/BHMA standard finish code, i.e. use "29" for polished stainless, ANSI/BHMA finish 629

How to Order 8200 Series Mortise Locks with Gramercy Levers

Options	Series	Function	Voltage	Rose/ Escutcheon	Lever	Finish	Hand
Select from pages 45-48	82	Select from pages 19-28	Specified for electrical functions	Select from pages 10-13	Leather insert	Bright stainless steel with brown leather	RHR, RH, LHR, or LH
10-	82	71	12VDC	LN	RAL	29BN29	RH

Gramercy Levers are available with E2, E3, E4, O, CO, TO, LN, CR, TR roses and CE, TE, LE1, VN1 escutcheons

Copyright © 2004-2021, SARGENT Manufacturing Company. All rights reserved. Reproduction in whole or in part without the express written permission of SARGENT Manufacturing Company is prohibited. Patent pending and/or patent www.assaabloy.com/patents.

90115 10/21

50

1-800-727-5477 • www.sargentlock.com

Experience a safer
and more open world

Multi-Functional Lockbody

8200/R8200/7800 Series Mortise Locks

How to Change Lock Function:

The Green Catch Screw must be located in the designated location as specified on the lock case to produce the desired function.

There are three locations: one location for 05, 37 & 38 functions; one location for 04, 06, 13, & 31 functions; and one location for 36 function.

Note: To change to functions 04, 06, 13, & 31, the hub must be at the 45° position as specified on the case before screwing in the green catch screw.

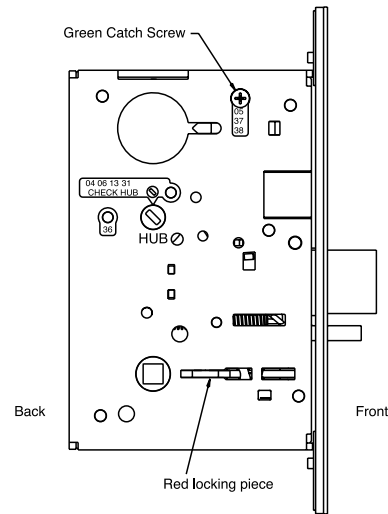

Function & Part Listing for the Multifunction Lockbody

Function	#41 Cylinder	Cyl. Collars	Lever/Knob Requirements	Thumb turn
04 Store Room / Closet (F07)	1	* 1 - 1KB	** Inside Trim Set & *** Outside Trim Set	Not used
05 Office / Entry (F04)	1	* 1 - 1KB	** Inside Trim Set & *** Outside Trim Set	++ 1
06 Store Room / Service	1	* 1 - 1KB	+ Trim One Side Kit, Inside Lever/ Knob & Rose/Escutcheon	Not used
13 Communicating / Exit	Not used	Not used	+ Trim One Side Kit, Inside Lever/ Knob & Rose/Escutcheon	Not used
31 Utility	1	* 1 - 1KB	+ Trim One Side Kit, Inside Lever/ Knob & Rose/Escutcheon	Not used
36 Closet	1	* 1 - 1KB	+ Trim One Side Kit, Inside Lever/ Knob & Rose/Escutcheon	Not used
37 Classroom (F05)	1	* 1 - 1KB	** Inside Trim Set & *** Outside Trim Set	Not used
38 Classroom Security (F32)	2	* 2 - 1KB-2	** Inside Trim Set & *** Outside Trim Set	Not used

***Cylinder Collars:** Noted are based on 1-3/4" Thick Doors with standard #41 size cylinders. Other sized doors and cylinders will require different collar sizes and possibly blocking rings - see chart on page 41 of this catalog for details

**** Inside trim sets include:** Inside lever/knob, inside rose or escutcheon, trim pack (spindles, through-bolt screws, set screw, inside adapter plate assembly), trim finish screws (for escutcheons)

***** Outside trim sets include:** Outside lever/knob, outside rose or escutcheon, outside mounting plate, two through-bolt studs, washers, retaining nut, and cylinder rosettes (for cylinder functions only)

+ Trim One-Side Kit includes: adapter assembly, spindle, through-bolt screws and plate adapter assembly. An inside lever is always used with this kit and is used on either side of the door as required

++ Thumb turn: Rose trims use 130KB thumb turn for Levers, and 130W thumb turn for Knobs.

Escutcheon trims require escutcheon to be ordered according to function/design, to receive thumb turn affixed to it

Type of Rose/Escutcheon		Kit Part Number
Trim One Side Kit	E, O, KW, LN & LW1 (Standard trim only — not for use with Studio levers)	82-3208
Trim One Side Kit	KE & LE (1 & 3) (Standard trim only — not for use with Studio levers)	82-3209
Trim One Side Kit	L Rose & WT	82-3210
Trim One Side Kit	Blank Rose (1-3/4" door)	82-4023

Note: 8200/R8200/7800 Series Mortise Locks are certified for all functions including electrical functions and trims without exceptions.

2.1 Heavy Duty Mortise Locks

- A. Heavy duty mortise locks shall be 8200/R8200/7800 Series as manufactured by SARGENT Manufacturing Company, New Haven, CT.
- B. Locks shall meet or exceed the requirements of ANSI/BHMA A156.13 Series 1000, Operational Grade 1, and Security Grade 1 with all standard trims.
- C. Locks shall be easily re-handed without opening the lockbody.
- D. Locks shall comply with UL 10C positive pressure requirements.
- E. Locks required for fire doors shall be listed by Underwriters Laboratories for ratings of A label (3 hours) and less, for doors up to 4'0" (1.2m) x 10' 0" (3.05m) and pairs of doors 8'0" (2.4m) x 10'0" (3.05m).
- F. Construction:
 - 1. Lock functions shall be manufactured in a single-sized case formed from 12 gauge steel minimum.
 - 2. Lock cases shall be closed on all sides and back.
 - 3. Locks shall have field adjustable, beveled, armored front, with a .125 inch (3mm) thickness minimum.
 - 4. Locks shall have a one piece, 3/4" inch (19mm) throw anti-friction stainless steel latch.
 - 5. Deadbolts, where specified, shall be full one inch (25mm) throw made of one-piece hardened stainless steel.
 - 6. Where required by the Federal Bureau of Prisons, locks can be furnished optionally with stainless steel hubs.
- G. Locks shall have a 2-3/4" (70mm) backset, standard.
- H. Strikes shall be non-handed with a curved lip.
- I. To ensure proper alignment, trim, knobs or levers, shall be through-bolted and fully interchangeable between rose and escutcheon.
- J. Locks shall have brass 6-Pin cylinder, standard.
- K. Provide status indicators with highly reflective color and wording for "locked/unlocked" or "vacant/occupied" with customer wording options if required. Indicator to be located above the cylinder with the inside thumbturn not blocking the visibility of the indicator status. Indicator window size to be a minimum of 2.1" x 0.6" with a curved design allowing a 180 degree viewing angle with protective covering to prevent tampering.
- L. Locks shall have a 10-year limited warranty. 2-year limited warranty on electrified locks.

- M. Behavioral Health, Mortise: ANSI/BHMA A156.13, Series 1000, Operational and Security Grade 1 mortise type manufactured to Office of Mental Health (OMH) requirements with behavioral health lever and rose trim or integrated trim. Locksets to be manufactured with a corrosion resistant, formed steel case. Levers and roses are manufactured from stainless steel material. Provide optional lead-lining (lock body), Torx® fasteners, and Antimicrobial coating as specified in Hardware Sets.

2.2 EcoFlex® Electrified Mortise Locks

- A. SARGENT 8200/R8200 Electrified Mortise Locks
 - 1. General: ANSI/BHMA certified extra heavy duty, lever type mortise lock conforming to ANSI/BHMA A156.13 Series 1000, Grade 1 requirements and ANSI A117.1 accessibility guidelines. All functions manufactured in a single sized case formed from a minimum 12 gauge steel. Lockset is field-adjustable for handing without opening the lock body with a beveled armored front that is 0.125" minimum thickness and utilizes a one-piece 3/4" anti-friction stainless steel latchbolt. To insure proper alignment, all trim, shall be thru-bolted and fully interchangeable between rose and escutcheon designs. Lock is UL listed and labeled for use on up to 3 hour fire rated openings.
 - a. Backsets: 2-3/4" .
 - b. Deadbolt: Optional 1" throw made of stainless steel and 2 hardened steel roller inserts.
 - c. Strikes: Provide wrought boxes and strikes with proper lip length to protect trim but not to project more than 1/8" beyond trim, frame or inactive leaf. Where required, provide open back strike and protected to allow practical and secure operation.
 - 2. Provide access control mortise lock series, type and functions where specified in hardware groups, with provisions below:
 - a. Emergency override access capability with key cylinder retraction of lock latch bolt without necessary electronic activation.
 - b. Inside lever retracts latch and deadbolt simultaneously for free egress.
 - c. Refer to "KEYING" specification section for keying system requirements.
 - 3. Locking and unlocking of the lever handle by electronic operation contained completely within the body of the mortise lock.
 - a. Field configurable Fail Safe /Fail Secure by means of an external DIP switch setting.
 - b. Operationally voltage-insensitive 12 to 24 VDC.
 - c. Energy Performance: Maximum standby current required for functional operation not to exceed 50 mA at 24 VDC limiting potential inductive kickback or the need for external diodes.
 - d. Functional locking operation not affected by cable runs greater than 500 feet using a minimum 22 AWG wire.
 - 4. Monitoring: Optional real time monitoring of latchbolt, deadbolt, door open/closed status and valid egress where specified. Valid egress signaled by activation of the Request-to-Exit (RX) micro switch integral to the inside lever of the lockset on the unsecure side of the door capable of shunting external alarms. Door open/closed status provided by monitoring the deadlatch and latchbolt in series with optional integrated magnetic door position switch.
 - 5. Perform centralized control of the integrated locking functions by means of a single cable run to the access control panel independent of any proprietary power supplies, interface boards or controllers.
 - a. End of line termination points by means of factory pre-wired Molex® connectors and harnesses.
 - b. Source power electrical hard wiring and connections by others.
 - 6. Specified Manufacturer: Sargent Manufacturing (SA) — 8200/R8200 Series.

- d. Lever and finish to match corresponding mechanical locking hardware.

- 3. Locking and unlocking of the lever handle by electronic operation contained completely within the body of the mortise lock.

- a. Field configurable Fail Safe /Fail Secure by means of an external DIP switch setting.

- b. Operationally voltage-insensitive 12 to 24 VDC.

- c. Energy Performance: Maximum standby current required for functional operation not to exceed 50 mA at 24 VDC limiting potential inductive kickback or the need for external diodes.

- d. Functional locking operation not affected by cable runs greater than 500 feet using a minimum 22 AWG wire.

- 4. Monitoring: Optional real time monitoring of latchbolt, deadbolt, door open/closed status and valid egress where specified. Valid egress signaled by activation of the Request-to-Exit (RX) micro switch integral to the inside lever of the lockset on the unsecure side of the door capable of shunting external alarms. Door open/closed status provided by monitoring the deadlatch and latchbolt in series with optional integrated magnetic door position switch.

- 5. Perform centralized control of the integrated locking functions by means of a single cable run to the access control panel independent of any proprietary power supplies, interface boards or controllers.

- a. End of line termination points by means of factory pre-wired Molex® connectors and harnesses.
- b. Source power electrical hard wiring and connections by others.

- 6. Specified Manufacturer: Sargent Manufacturing (SA) — 8200/R8200 Series.

Notes

8200/R8200/7800 Series Mortise Locks

SARGENT
ASSA ABLOY

Copyright © 2004-2021, SARGENT Manufacturing Company. All rights reserved. Reproduction in whole or in part without the express written permission of SARGENT Manufacturing Company is prohibited. Patent pending and/or patent www.assaabloydss.com/patents.

The ASSA ABLOY Group is the global leader in access solutions. Every day, we help billions of people experience a more open world.

ASSA ABLOY Opening Solutions leads the development within door openings and products for access solutions in homes, businesses and institutions. Our offering includes doors, frames, door and window hardware, locks, perimeter fencing, access control and service.



SARGENT Manufacturing Company
100 Sargent Drive
New Haven, CT 06511 USA
800-727-5477
www.sargentlock.com

Founded in the early 1800s, SARGENT® is a market leader in locksets, cylinders, door closers, exit devices, electro-mechanical products and access control systems for new construction, renovation, and replacement applications. The company's customer base includes commercial construction, institutional, and industrial markets.

Copyright © 2010-2021, SARGENT Manufacturing Company. All rights reserved. Reproduction in whole or in part without the express written permission of SARGENT Manufacturing Company is prohibited. Patent pending and/or patent www.assaabloydss.com/patents.