

DC700 with G462 / G464

Door closer with Cam-Motion® technology, integrated mechanical door coordinator and electro-mechanical hold-open device(s).



ASSA ABLOY DC700 with G462 / G464

- Door closer with Cam-Motion® technology and guide rail with integrated mechanical door coordinator and two electromechanical hold-open devices for double-leaf doors
- Certified in compliance with EN1154, EN1155 and EN1158, size 3-6
- Operates independently of door closers and offers best possible functions, safety and reliability
- Suitable for fire and smoke protection double leaf doors, hinge distance 1350 - 2800 mm, non-hinge side installation hinge distance 1400 - 2800 mm

Characteristics of DC700 with G462 / G464

- Continuously adjustable holding force
- Correct closing sequence guaranteed for double leaf doors, inactive leaf closes before active leaf starts to close
- Standard mounting position on hinge side and non-hinge side
- Non-hinge side mounting requires hook arm G120
- Axis continuously height adjustable up to 14 mm
- Large range of applications
- Standard colours: silver EV1; white, similar to RAL9016; brown, similar to RAL8014; black, similar to RAL9005, stainless steel
- Customised finishes available on request
- G462 hold-open angle adjustable between 70°-130° on hinge side and 70°-120° on non-hinge side
- G464 inactive door leaf hold-open angle adjustable between 70°-130° on hinge side and 70°-120° on non-hinge side



CE	Abloy Oy, PO Box 108 80101 Joensuu Finland	16	3	8	6	3	1	1	4
	DC700								
Dangerous substances: None									

CE	Abloy Oy, PO Box 108 80101 Joensuu, Finland	10	3	8	6	3	1	1	3
	0432-CPD-0049								
Dangerous substances: None									

CE	Abloy Oy, PO Box 108 80101 Joensuu, Finland	10	3	8	6	3	1	1	3
	0432-CPD-0050								
Dangerous substances: None									

Characteristics of G462

- Integrated mechanical coordinator with two electro-mechanical hold-open devices
- Possible to keep active leaf or both door leaves open

Characteristics of G464

- Integrated mechanical coordinator with one electro-mechanical hold-open device
- Possible to keep both door leaves open
- Active leaf can stay open in any selected angle up to 150° when inactive leaf is open

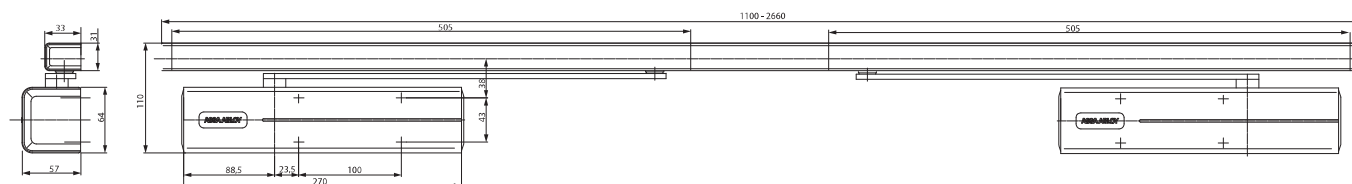

DC700 with G462 / G464

Technical attributes

Guide rail G462/G464

Technical attributes	
Max. door opening angle of active leaf (hinge side/non-hinge side)	170° / 105°
Hold-open angle of inactive leaf (hinge side / non-hinge side)	70° - 130° / 70° - 115°
Hinge distance (hinge side)	1350 - 2800 mm
Hinge distance (non-hinge side)	1400 - 2800 mm
Required power supply	24 V DC
Weight G462 / G464	3.1kg / 2.9 kg
Height	34 mm
Depth	33 mm
Length	Depends on hinge distance
Suitable for fire doors	Yes
Certified in compliance with	EN1154 / EN1155 / EN1158
CE marking for building products	Yes

Facts for door closer see DC700

The advantages at a glance

Customer segment	Advantages
Project planners	- Extensive range of uses: Fire and smoke protection doors - Modern design - Compact design - Applications where both door leaves need to keep open
Builders	- Adjustable to nearly any door and frame types - Quick and easy installation - Quickly and easily adjustable - Suitable for hinge and non-hinge side installations
Trade	- Reduced inventory costs due to modular product range - One single product suitable for a large variety of mounting positions
User	- Correct closing sequence guaranteed in every situation - Adjustable operating force, to meet door construction requirements and user need

Our service for you: here you can see the individual advantages of our door closer models for your respective field of business.

You can find the complete specification on the internet at: www.assaabloy.de

Specification for G462 / G464

ASSA ABLOY guide rail with mechanical coordinator and electro-mechanical hold-open device for double leaf doors used with DC700 Cam-Motion® technology door closers

- Hinge distance 1250 - 2800 mm
- Hold-open angle of inactive leaf adjustable between 70° - 130°
- Continuously adjustable holding force
- Correct closing sequence guaranteed for double leaf doors, inactive leaf closes before active leaf starts to close
- Standard mounting position on hinge side and non-hinge side
- Non-hinge side mounting requires hook arm G120
- Axis continuously height adjustable up to 14 mm
- Large range of applications
- Possible to keep active leaf or both door leaves open (G462)
- Possible to keep both door leaves open (G464)

Accessories:

- Mounting plate A115
- Angle bracket A116
- Angle bracket A117
- Hook arm G120 for non-hinge side mounting
- Carry bar A101 for hinge side installations
- Carry bar A102 for non-hinge side installations
- Smoke detector
- Flush mounted or surface mounted release button
- Mechanical bearing A151, for double doors
- Smoke protection detector A177
- Flush mounted door release button A178
- Opening damper A191

Colour:

- Silver EV1
- White, similar to RAL9016
- Brown, similar to RAL8014
- Black, similar to RAL9005
- Stainless steel
- Customised finish

DC700 with G462 / G464

Dimensional drawings and accessories

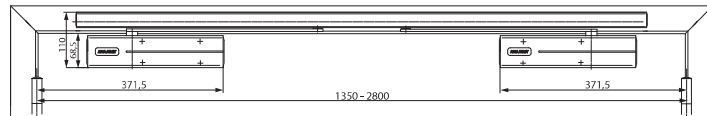
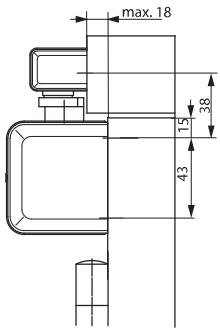

Regular mounting on hinge side
 Left handed shown in diagram
 Right handed is the reverse

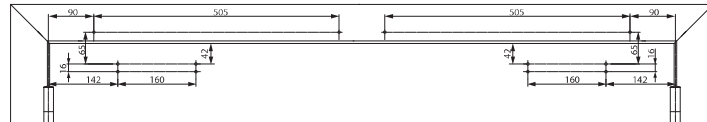

Installation dimensions with mounting plate for standard mounting on hinge side
 Right handed door is active leaf
 Left handed door is inactive leaf

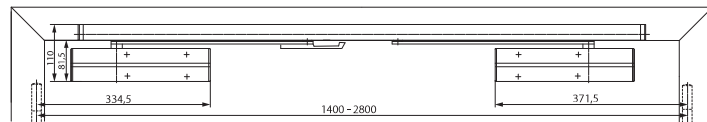

Regular mounting on non-hinge side
 Right handed door is active leaf
 Left handed door is inactive leaf

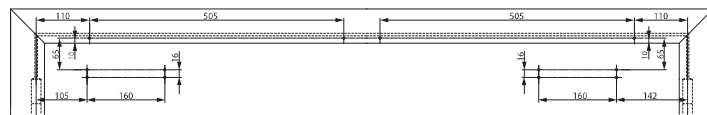

Installation dimensions with mounting plate for standard mounting non hinge side
 Right handed door is active leaf
 Left handed door is inactive leaf

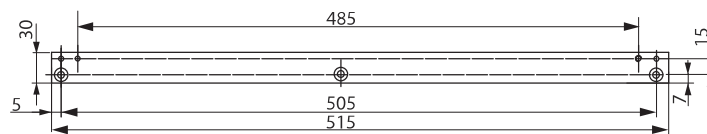
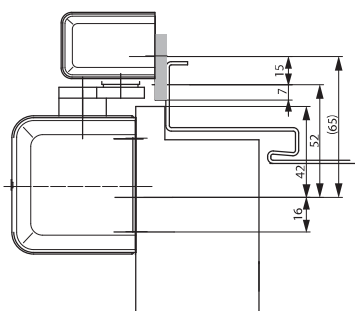

Mounting plate A115
 For guide rail G464 and G462
 1pc for active door leaf

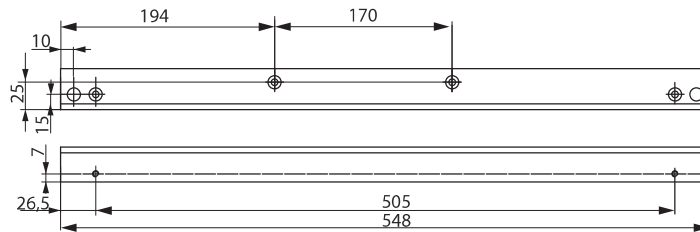
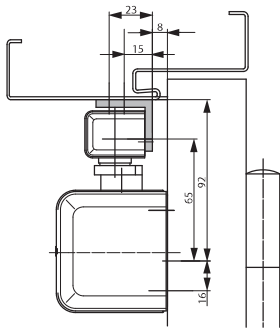

Angle bracket A116

For guide rails G464 and G462

1 pc for active door leaf
1 pc for passive door leaf

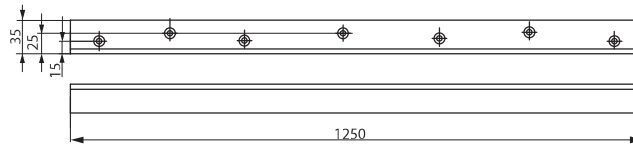

Angle bracket A117

For guide rails G464 and G462

Hook arm G120

For double leaf doors non-hinge side mounting

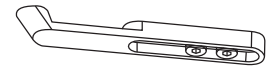

Carry bar A101

Enables the correct opening sequence of double doors, installed to inactive door leaf on non-hinge side
(G461/G462/G464 installed on hinge side)

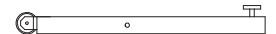

Carry bar A102

Enables the correct opening sequence of double doors, installed to inactive door leaf on non-hinge side
(G461/G462/G464 installed on non-hinge side)



Opening damper A191

Helps to prevent the door and door handle from hitting a return wall.
Simple fitting into guide rail and continuously adjustable.
Does not replace a door stop.
Can be used only with G464 on active leaf.

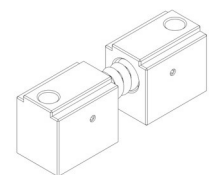

DC700 with G462 / G464

Accessories and order placement information

Smoke protection detector A177 (optical)

Operating voltage 15-30 V DC



Flush mounted door release button A178

For manual release of hold-open.



Designation / Item	Order no.
Guide rail G462 with mechanical coordinator and two electro-mechanical hold-open devices, silver EV1	DCG462----DEV1-
Guide rail G462 with mechanical coordinator and two electro-mechanical hold-open devices, white, similar to RAL9016	DCG462----D9016
Guide rail G462 with mechanical coordinator and two electro-mechanical hold-open devices, brown, similar to RAL8014	DCG462----D8014
Guide rail G462 with mechanical coordinator and two electro-mechanical hold-open devices, black, similar to RAL 9005	DCG462----D9005
Guide rail G462 with mechanical coordinator and two electro-mechanical hold-open devices, stainless steel	DCG462----D35--
Guide rail G462 with mechanical coordinator and two electro-mechanical hold-open devices, customised finish	DCG462----DXXXX
Guide rail G464 with mechanical coordinator and electro-mechanical hold-open device, silver EV1	DCCG464----DEV1-
Guide rail G464 with mechanical coordinator and electro-mechanical hold-open device, white, similar to RAL9016	DCCG464----D9016
Guide rail G464 with mechanical coordinator and electro-mechanical hold-open device, brown, similar to RAL8014	DCCG464----D8014
Guide rail G464 with mechanical coordinator and electro-mechanical hold-open device, black, similar to RAL 9005	DCCG464----D9005

Designation / Item	Order no.
Guide rail G464 with mechanical coordinator and electro-mechanical hold-open device, stainless steel	DCCG464----D35--
Guide rail G464 with mechanical coordinator and electro-mechanical hold-open device, customised finish	DCCG464----DXXXX
Carry bar A101	DCA101-----
Carry bar A102	DCA102-----
Mounting plate A115, silver EV1	DCA115----EV1-
Mounting plate A115, customised finish	DCA115----XXXX
Angle bracket A116, silver EV1	DCA116----EV1-
Angle bracket A116, customised finish	DCA116----XXXX
Angle bracket A117, silver EV1	DCA117----EV1-
Angle bracket A117, customised finish	DCA117----XXXX
Hook arm G120, silver EV1	DCG120----EV1-
Hook arm G120, white, similar to RAL9016	DCG120----9016
Hook arm G120, brown, similar to RAL8014	DCG120----8014
Hook arm G120, black, similar to RAL 9005	DCG120----9005
Hook arm G120, black, similar to RAL 9005	DCG120----35--
Hook arm G120, customised finish	DCG120----XXXX
Mechanical bearing A151, for double doors	DCA151-----
Smoke protection detector A177	DCA177-----
Flush mounted door release button A178	DCA178-----
Opening damper A191	DCA191-----