

Serie 750

750 Series



ASSA ABLOY, the global leader
in door opening solutions



Chiudiporta a pavimento per porte di grandi dimensioni e peso, a potenza regolabile

Floor spring with adjustable power for large and very heavy doors

Caratteristiche tecniche:

- Forza regolabile in continuo EN 3-6 che unita ad alta efficienza permette una vera personalizzazione delle forze di apertura e chiusura.
- Indicato per porte di grandi dimensioni e peso fino a 300 Kg, grazie alla grossa cilindrata del pistone che assicura un reale controllo idraulico anti-abbrivio.
- Chiusura sotto controllo idraulico da circa 175° in entrambi i sensi. A richiesta disponibile versione con controllo da 180°. Mano da specificare.
- Due valvole termostatiche indipendenti per accurato controllo di chiusura generale, scatto o smorzamento finale.
- Fermaporta a 90°, 105° o senza fermo.
- Effetto freno all'apertura.
- Valvola di sovrappressione.
- Ampia regolazione in tutti i sensi nella cassetta a murare per recuperare eventuali disallineamenti o dislivelli senza smontare la porta.
- Corpo in ghisa.
- Cassetta a murare zincata a caldo.
- Varietà di perni disponibili: italiano, tedesco, francese.
- Perno intercambiabile da 0 a + 30 mm.
- Finiture architettoniche: piastra in acciaio inox lucido o satinato e ottone lucido.
- Ritardo di chiusura (optional) tra circa 175° e 80° controllato da valvola idraulica. Con questa opzione non si ha lo scatto finale.
- Tutti i modelli hanno certificazione prodotto EN1154. La versione senza fermaporta ha la conformità **CE**

Specifica per capitolati

Chiudiporta a pavimento a forza regolabile in continuo, certificato EN 3-6, **CE**, due valvole di velocità a canali idraulici indipendenti, perno intercambiabile, freno meccanico all'apertura, valvola di sovrappressione, regolazione verticale di 9 mm. a porta montata, per uso gravoso, portata 300 Kg, MAB 750

Features:

- Adjustable power EN 3-6 by means of stepless governor which coupled with high efficiency allows a real personalization of opening/closing forces.
- Recommended for large and very heavy doors up to 300 kg. thanks to large piston displacement that ensures a real hydraulically controlled damping action.
- Closing from approx 175° in both swings under hydraulic control. Handed version with control from 180° available on request.
- Two independent thermostatic valves for precise adjustment of general closing speed, final latch or final damping.
- Hold open at 90°, 105° or non hold open.
- Back Check effect.
- Overpressure relief valve to protect unit against abuse.
- Large range of adjustment within cement box to solve possible alignment problems on site without taking down the door.
- Cast iron body.
- Cement box in hot zinc plated steel.
- Variety of available spindles: square Italian, square French, rectangular German.
- Interchangeable spindle from 0 to + 30 mm.
- Architectural finishes: coverplate in polished s/steel, satin s/steel, polished brass.
- Delayed closing action (optional) between approx. 175° and 80° controlled by hydraulic valve. With this option final latch is not performed.
- All models have quality certification EN1154. Version without Hold Open has **CE** conformity.

Specifications

Heavy duty floor spring with stepless power adjustment EN3-6, certified **CE**, two closing speed valves with independent hydraulic circuits, interchangeable spindle, mechanical Back Check, overpressure relief valve, vertical adjustment of 9 mm within cement box, max. load 300 kg, MAB 750.



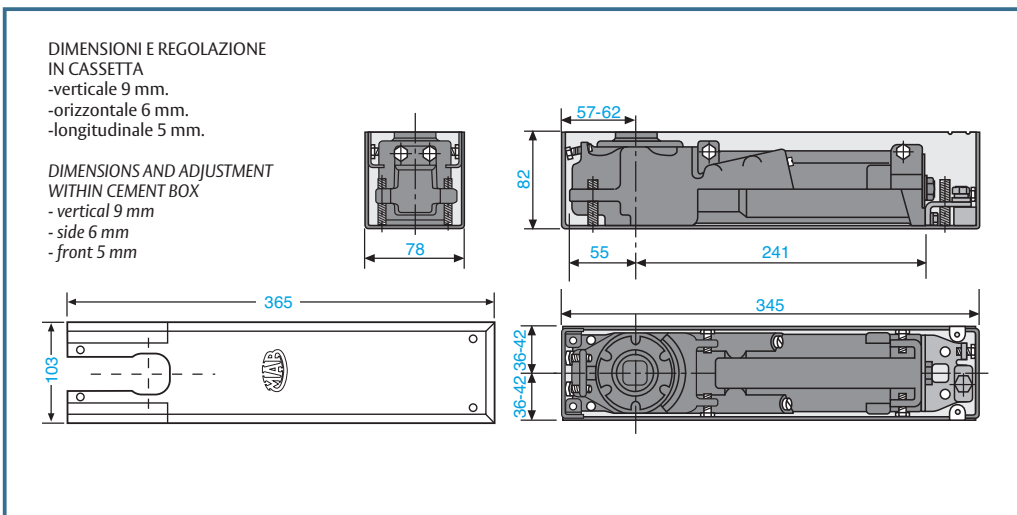

Regolazione della velocità e potenza *Power and closing speed*

Avvitando il registro \odot 17 mm, la forza aumenta.
 Svitando il registro, la forza diminuisce.
 Con 10 giri completi si passa da forza minima a forza massima.
 Le valvole termostatiche ① e ② controllano in modo indipendente la velocità di chiusura generale $\sim 175^\circ - 15^\circ$ e la velocità finale $\sim 15^\circ - 0^\circ$ (costante, smorzata o con scatto).
 Con 3 giri completi in senso antiorario si passa da valvola chiusa a velocità massima.

Turn clockwise force adjuster \odot 17 mm to increase power.
 Turn anti-clockwise to decrease power. Starting from the minimum power, with 10 complete turns maximum power is reached.
 Thermostatic valves ① and ② control independently the general closing speed from $\sim 175^\circ$ to 15° and the final closing from $\sim 15^\circ$ to 0° (constant, damping or latching). Starting from valve closed, maximum speed is reached with three full turns anti-clockwise.

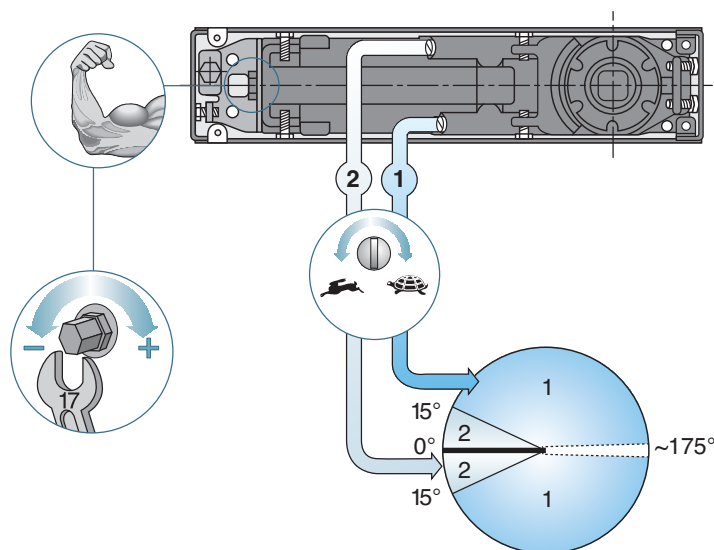

Dimensioni massime delle porte *Recommended door sizes*

Forza minima
 Min. power **3** = 24 Nm

Forza massima
 Max. power **6** = 60 Nm

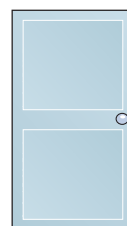

min. 850 x 2300 300 Kg

max. 1400 x 2500 300 Kg

Codice articolo secondo angolo di fermo *Article reference according to hold open*

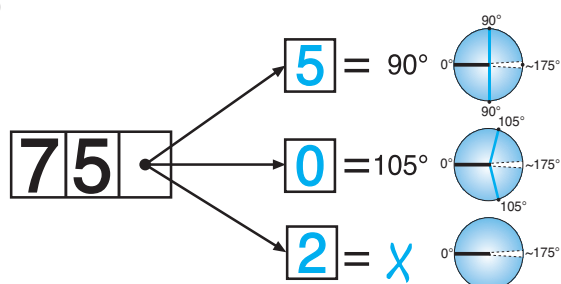

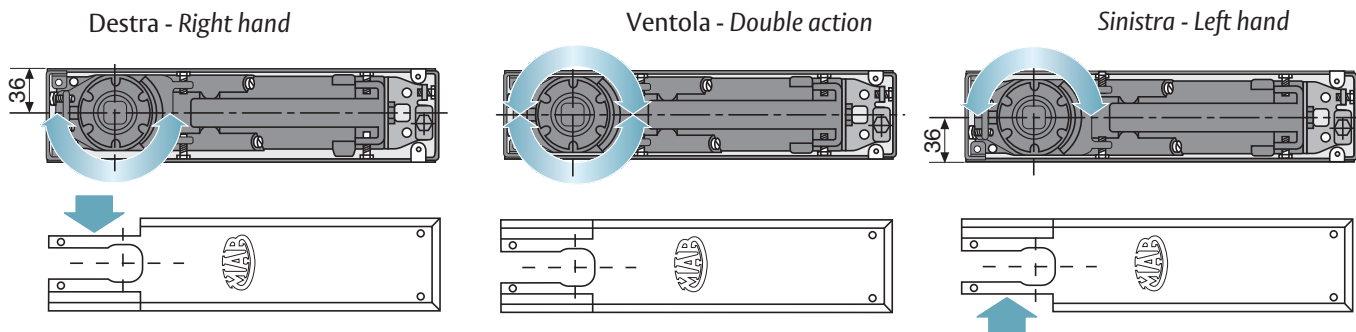

Accessori / Accessories

Codice / Code

Braccio inferiore reversibile in acciaio per porte a ventola. Cava quadro italiano
Reversible bottom arm in steel for double action doors. Square Italian spindle

AC 115

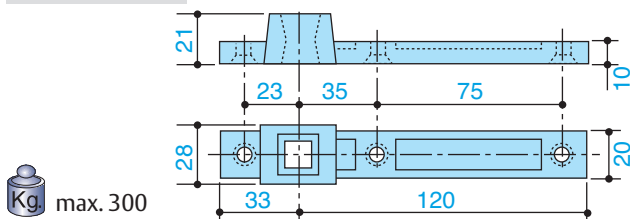

Codice / Code

Braccio inferiore in acciaio per porte a ventola. Cava quadro italiano.
Bottom arm in steel for double action doors. Square Italian spindle.

AC 297

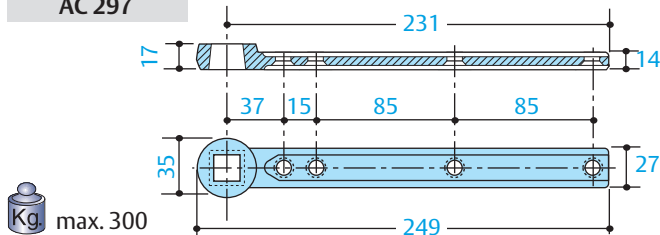

Codice / Code

Braccio inferiore in acciaio per porte a ventola. Cava rettangolare tedesca.
Bottom arm in steel for double action doors. Rectangular German spindle.

AC 298

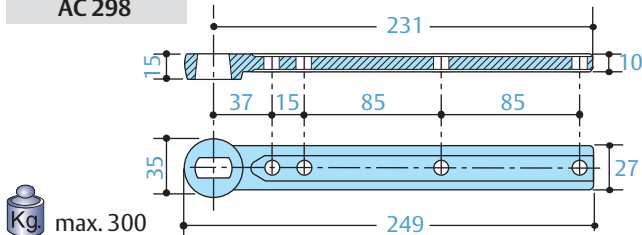

Codice / Code

Braccio inferiore reversibile in acciaio per porte a ventola. Cava rettangolare tedesca.
Reversible bottom arm in steel for double action doors. Rectangular German spindle.

AC 393

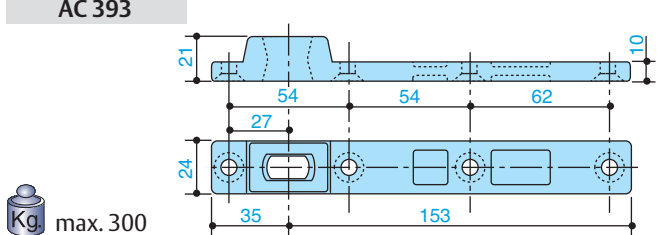

Codice / Code

Perno superiore in acciaio massiccio per porte a ventola, con boccia autolubrificante.
Double acting top pivot in full steel with self lubricating bushing.

AC 375

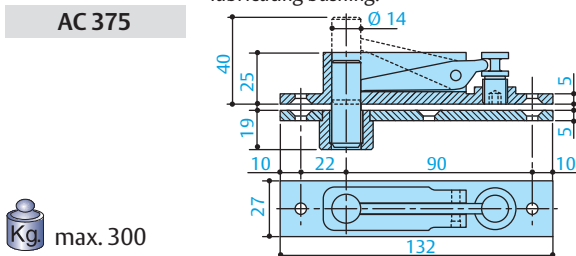

Codice / Code

Perno superiore per porte a ventola.
Double acting top pivot.

AC 8

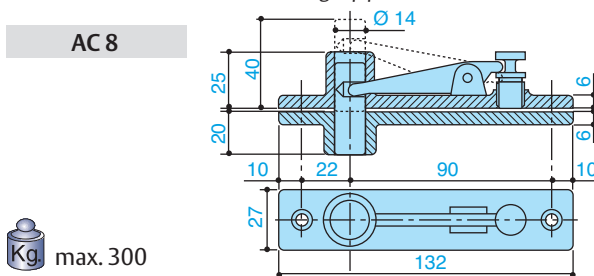

Codice / Code

AC 583

Braccio inferiore destro e sinistro in acciaio per porte a battente, interasse mm 36.
Cava quadro italiano.
Right and left bottom arm in steel for single acting doors, 36 mm offset. Square Italian spindle.

max. 300

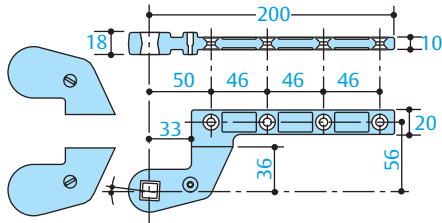

Codice / Code

AC 392

Braccio inferiore destro e sinistro in acciaio per porte a battente, interasse mm 36.
Cava rettangolare tedesca.
Right and left bottom arm in steel for single acting doors, 36 mm offset. Rectangular German socket.

max. 300

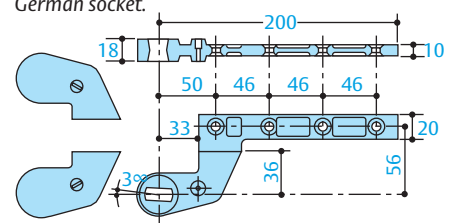

Codice / Code

AC 384

Perno superiore in acciaio per porte a battente sinistre o destre, interasse mm 36.
Top pivot in steel for left or right doors 36 mm. offset.

max. 300

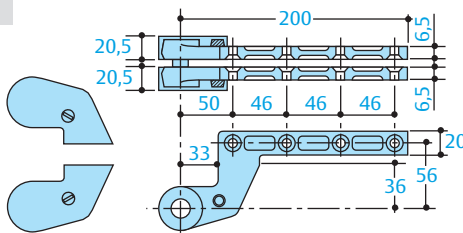

Perni intercambiabili Detachable spindles

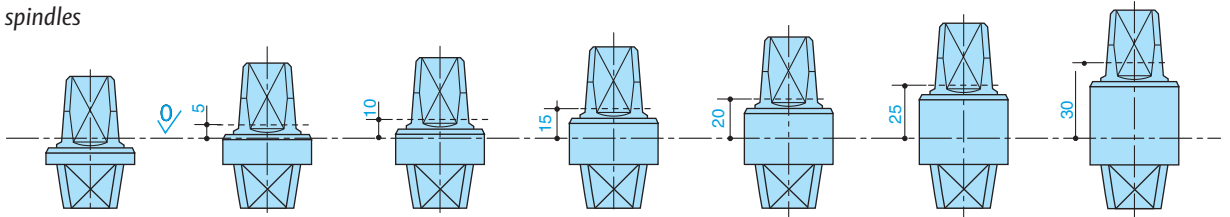

Codice / Code	Codice / Code	Codice / Code	Codice / Code	Codice / Code	Codice / Code	Codice / Code
AC 340	AC 341	AC 342	AC 343	AC 344	AC 345	AC 346
AC 350	AC 351	AC 352	AC 353	AC 354	AC 355	AC 356
AC 360	AC 361	AC 362	AC 363	AC 364	AC 365	AC 366



ASSA ABLOY Italia S.p.A.
Via Bovaresa 13/15 - 40017 San Giovanni in Persiceto (BO) Italy
Tel. +39 051 6812411 - Fax +39 051 827486
info@assaabloy.it - www.assaabloy.it

ASSA ABLOY is the
global leader in door
opening solutions,
dedicated to satisfying
end-user needs for
security, safety and
convenience.

www.assaabloy.com

MAB
ASSA ABLOY

ASSA ABLOY Italia S.p.A. si riserva di apportare in qualunque momento e senza preavviso le modifiche necessarie per migliorare ed evolvere le caratteristiche dei propri prodotti. Fotografie, illustrazioni e descrizioni sono da ritenersi indicative.
ASSA ABLOY Italia S.p.A. reserves the right at any time and without notice, to necessary modifications in order to improve and evolve the characteristics of their products. Photographs, illustrations and descriptions ought to be considered as indicative.

H001E14 / 04-2011